

THT



Extractores helicoidales tubulares 400°C/2h y 300°C/2h

Extractores helicoidales tubulares con carcasa corta, para trabajar inmersos en zonas de riesgo de incendios 400°C/2h.

Ventilador:

- Envoltente tubular en chapa de acero.
- Hélices orientables en fundición de aluminio
- Homologación según norma EN-12101-3-2002
- Dirección aire motor-hélice

Motor:

- Motores clase H, uso continuo S1 y uso emergencia S2, con rodamientos a bolas, protección IP55, de 1 ó 2 velocidades según modelo
- Motor Multitensión, diseño especial válido para: 220/380V 60Hz, 254/440V 60Hz, 265/460V 60Hz, 277/480V 60Hz
- Temperatura máxima del aire a transportar: Servicio S1 -20°C+ 40°C en continuo, Servicio S2, 300°C/2h, 400°C/2h

Acabado:

- Anticorrosivo en resina de poliéster polimerizada a 190 °C, previo desengrase con tratamiento nanotecnológico libre de fosfatos.

Bajo demanda:

- Extractores con carcasa larga equipada con trampilla de inspección
- Hélices reversibles 100%



Código de pedido

De tamaño 40 a tamaño 100

THT	—	56	—	4T	—	2	—	F-400	—	60Hz
THT: Extractores helicoidales tubulares 400°C/2h y 300°C/2h		Diámetro hélice en cm.		Número de polos motor 2=3500 r/min. 60 Hz 4=1680 r/min. 60 Hz 6=1080 r/min. 60 Hz 8=900 r/min. 60 Hz 12=750 r/min. 60 Hz	T=Trifásico	Potencia motor (c.v.)		F-300: Homologación 300°C/2h F-400: Homologación 400°C/2h		
THT/CL: Extractores helicoidales tubulares 400°C/2h y 300°C/2h con carcasa larga, equipada con trampilla de inspección										

De tamaño 125 a tamaño 160

THT	—	125	—	4T	—	15	—	9-10	—	F-400	—	60Hz
THT: Extractores helicoidales tubulares 400°C/2h y 300°C/2h		Diámetro hélice en cm.		Número de polos motor 2=3500 r/min. 60 Hz 4=1680 r/min. 60 Hz 6=1080 r/min. 60 Hz 8=900 r/min. 60 Hz 12=750 r/min. 60 Hz	T=Trifásico	Potencia motor (c.v.)		Número de palas 3 palas 6 palas 9 palas	Angulo inclinación palas	F-300: Homologación 300°C/2h F-400: Homologación 400°C/2h		
THT/CL: Extractores helicoidales tubulares 400°C/2h y 300°C/2h con carcasa larga, equipada con trampilla de inspección												

Características técnicas

Modelo	Velocidad (r/min)	Intensidad máxima admisible (A)		Potencia instalada (kW)	Caudal máximo (m³/h)	Nivel presión sonora dB(A)	Peso aprox. (Kg)	
		220-277V	380-480V				Larga	Corta
THT-40-2T-1,5	3455	4,70	2,70	1,10	6750	76	33	31
THT-40-2/4T-1,5	3505/1750		2,90/2,10	1,10/0,25	6750/3400	76/61	34	32
THT-40-2T-2	3455	5,90	3,40	1,50	7350	77	35	33
THT-40-2/4T-2	3530/1750		4,40/1,40	1,50/0,37	7350/3650	77/62	35	33
THT-40-4T-0,75	1690	2,73	1,57	0,55	5800	64	32	29
THT-40-6T-0,75	1150	4,10	2,40	0,55	3800	53	37	34
THT-40-6/12T-0,75	1130/530		1,60/0,55	0,55/0,09	3800/1750	53/38	41	38
THT-45-2T-2	3455	5,90	3,40	1,50	8800	78	38	34
THT-45-2/4T-2	3530/1750		5,70/1,80	1,50/0,37	8800/4400	78/63	37	34
THT-45-2T-3	3480	8,70	5,00	2,20	11300	80	39	36
THT-45-2/4T-3	3515/1740		4,40/1,40	2,20/0,60	11300/5650	80/65	39	36
THT-45-4T-0,75	1690	2,73	1,57	0,55	7500	68	34	30
THT-45-6T-0,75	1150	4,10	2,40	0,55	6050	55	38	35
THT-45-6/12T-0,75	1130/530		1,60/0,55	0,55/0,09	6050/2800	55/40	42	39
THT-50-2T-4	3455	11,20	6,50	3,00	12100	82	49	42
THT-50-2/4T-4	3505/1730		6,70/2,00	3,00/0,80	12100/6050	82/67	51	44
THT-50-2T-5,5	3470		9,30	4,00	14300	83	65	57
THT-50-2/4T-6	3515/1740		10,00/3,20	4,50/1,30	15400/7700	83/68	67	60
THT-50-4T-1	1700	3,50	2,03	0,75	8950	69	37	33
THT-50-6T-0,75	1150	4,10	2,40	0,55	9150	57	40	36
THT-50-6/12T-0,75	1130/530		1,60/0,55	0,55/0,09	9150/4250	57/42	44	40
THT-56-2T-5,5	3505		9,50	4,00	18150	88	69	60
THT-56-2/4T-6	3515/1740		10,00/3,20	4,50/1,30	19650/9800	88/72	71	63
THT-56-2T-12	3540		19,20	9,00	27000	89	147	139
THT-56-2/4T-12	3505/1730		20,70/5,50	9,00/2,50	27000/13500	89/74	137	129
THT-56-4T-1	1715	3,50	2,00	0,75	10550	73	45	40
THT-56-4T-1,5	1715	4,80	2,80	1,10	12750	74	44	40
THT-56-4/8T-1,5	1730/850		2,90/1,40	1,10/0,25	12750/6300	74/59	48	43
THT-56-4T-2	1705	6,20	3,60	1,50	15000	75	48	43
THT-56-4/8T-2	1700/860		3,60/1,50	1,50/0,30	15000/7400	75/60	59	55
THT-56-6T-0,75	1150	4,10	2,40	0,55	10650	62	44	39
THT-56-6/12T-0,75	1130/530		1,60/0,55	0,55/0,09	10650/4950	62/47	48	43
THT-63-2T-12	3540		19,20	9,00	33100	90	161	143
THT-63-2/4T-12	3505/1730		18,50/5,50	9,00/2,50	33100/16550	90/75	151	133
THT-63-2T-22	3550		32,30	16,00	44750	91	188	170
THT-63-2/4T-22	3550/1775		32,30/8,90	16,00/4,00	44750/22400	91/76	188	170
THT-63-4T-1	1715	3,50	2,00	0,75	13800	73	49	43
THT-63-4T-1,5	1715	4,80	2,80	1,10	16550	74	51	45
THT-63-4/8T-1,5	1730/850		2,90/1,40	1,10/0,25	16550/8200	74/59	55	49
THT-63-4T-2	1705	6,20	3,60	1,50	19100	75	55	49
THT-63-4/8T-2	1700/860		3,60/1,50	1,50/0,30	19100/9450	75/60	70	60
THT-63-4T-3	1715	9,00	5,20	2,20	22400	76	64	54
THT-63-4/8T-3	1700/860		5,20/1,90	2,20/0,45	22400/11050	76/61	77	66
THT-63-4T-4	1715	11,40	6,60	3,00	25150	77	73	63
THT-63-4/8T-4	1710/850		6,80/2,20	3,00/0,60	25150/12450	77/62	86	77
THT-63-6T-0,75	1150	4,10	2,40	0,55	14650	65	51	45
THT-63-6/12T-0,75	1130/530		1,60/0,55	0,55/0,09	14650/6800	65/50	55	49
THT-63-6T-1	1140	4,70	2,70	0,75	15900	66	54	48
THT-63-6/12T-1	1130/530		2,20/0,87	0,75/0,15	15900/7400	66/51	61	55
THT-71-4T-1,5	1715	4,80	2,80	1,10	19950	78	58	52
THT-71-4/8T-1,5	1730/850		2,90/1,40	1,10/0,25	19950/9850	78/63	61	56
THT-71-4T-2	1705	6,20	3,60	1,50	19950	79	61	56
THT-71-4/8T-2	1700/860		3,60/1,50	1,50/0,30	19950/9850	79/64	76	67
THT-71-4T-3	1715	9,00	5,20	2,20	25250	81	70	61
THT-71-4/8T-3	1700/860		5,20/1,90	2,20/0,45	25250/12450	81/66	82	74
THT-71-4T-4	1715	11,40	6,60	3,00	28100	82	79	70
THT-71-4/8T-4	1710/850		6,80/2,20	3,00/0,60	28100/13900	82/67	92	83
THT-71-6T-0,75	1150	4,10	2,40	0,55	15400	67	57	52

Características técnicas

Modelo	Velocidad (r/min)	Intensidad máxima admisible (A)		Potencia instalada (kW)	Caudal máximo (m³/h)	Nivel presión sonora dB(A)	Peso aprox. (Kg)	
		220-277V	380-480V				Larga	Corta
THT-71-6/12T-0,75	1130/530		1,60/0,55	0,55/0,09	15400/7150	67/52	61	56
THT-71-6T-1	1140	4,70	2,70	0,75	17450	68	61	55
THT-71-6/12T-1	1130/530		2,20/0,87	0,75/0,15	17450/8100	68/53	67	62
THT-71-6T-1,5	1130	5,50	3,20	1,10	20300	69	69	61
THT-71-6/12T-1,5	1140/565		3,00/1,15	1,10/0,18	20300/9450	69/54	77	69
THT-80-4T-3	1715	9,00	5,20	2,20	25050	82	79	69
THT-80-4/8T-3	1700/860		5,20/1,90	2,20/0,45	25050/12400	82/67	91	82
THT-80-4T-4	1715	11,40	6,60	3,00	27850	83	88	78
THT-80-4/8T-4	1710/850		6,80/2,20	3,00/0,60	27850/13750	83/68	101	92
THT-80-4T-5,5	1720		8,40	4,00	33450	84	94	85
THT-80-4/8T-5,5	1745/870		9,30/3,40	4,00/0,80	33450/16550	84/69	127	118
THT-80-6T-1,5	1130	5,50	3,20	1,10	20100	72	78	69
THT-80-6/12T-1,5	1140/565		3,00/1,15	1,10/0,18	20100/9350	72/57	86	77
THT-80-6T-2	1135	7,40	4,30	1,50	23900	73	87	78
THT-80-6/12T-2	1140/550		4,60/1,90	1,50/0,25	23900/11100	73/58	91	82
THT-80-6T-3	1120	9,50	5,50	2,20	30150	74	94	84
THT-80-6/12T-3	1130/565		5,60/2,20	2,20/0,37	30150/14000	74/59	100	91
THT-80-8T-0,75	840	3,60	2,10	0,55	16550	70	71	62
THT-80-8T-1	850	4,80	2,80	0,75	19550	71	78	69
THT-90-4T-4	1715	11,40	6,60	3,00	34700	87	110	93
THT-90-4/8T-4	1710/850		6,80/2,20	3,00/0,60	34700/17150	87/72	124	106
THT-90-4T-5,5	1720		8,40	4,00	39900	89	117	99
THT-90-4/8T-5,5	1745/870		9,30/3,40	4,00/0,80	39900/19700	89/74	150	132
THT-90-4T-7,5	1750		12,60	5,50	43350	91	143	126
THT-90-4/8T-7,5	1745/870		12,80/4,60	5,50/1,10	43350/21450	91/76	157	140
THT-90-4T-10	1750		17,70	7,50	50000	92	154	137
THT-90-4/8T-9	1745/870		15,60/6,30	6,70/1,50	46850/23150	92/77	157	140
THT-90-6T-2	1135	7,40	4,30	1,50	28400	77	110	92
THT-90-6/12T-2	1140/550		4,60/1,90	1,50/0,25	28400/13200	77/62	114	96
THT-90-6T-3	1120	9,50	5,50	2,20	32750	78	116	99
THT-90-6/12T-3	1130/565		5,60/2,20	2,20/0,37	32750/15250	78/63	123	105
THT-90-6T-4	1165	13,50	7,80	3,00	38150	79	142	124
THT-90-6/12T-4	1150/570		8,90/3,50	3,00/0,55	38150/17750	79/64	143	126
THT-90-8T-1	850	4,80	2,80	0,75	23150	71	100	84
THT-90-8T-2	850	7,80	4,50	1,50	29850	73	116	99
THT-90-8T-3	850	11,40	6,60	2,20	35350	74	134	116
THT-100-4T-7,5	1750		12,60	5,50	51700	92	151	131
THT-100-4/8T-7,5	1745/870		12,80/4,60	5,50/1,10	46950/23200	92/77	165	145
THT-100-4T-10	1750		17,70	7,50	56400	93	162	142
THT-100-4/8T-9	1745/870		15,60/6,30	6,70/1,50	56400/27900	93/78	165	145
THT-100-4T-15	1750		22,00	11,00	65850	94	215	195
THT-100-4/8T-15	1765/870		23,20/8,70	11,00/2,80	65850/32550	94/79	215	195
THT-100-4T-20	1750		29,00	15,00	72500	95	230	210
THT-100-4/8T-20	1765/870		31,70/11,80	15,00/3,80	72500/35850	95/80	230	210
THT-100-6T-3	1120	9,50	5,50	2,20	36950	82	124	105
THT-100-6/12T-3	1130/565		5,60/2,20	2,20/0,37	36950/17200	82/67	130	112
THT-100-6T-4	1165	13,50	7,80	3,00	43150	83	150	130
THT-100-6/12T-4	1150/570		8,90/3,50	3,00/0,55	43150/20050	83/68	151	131
THT-100-6T-5,5	1165		11,00	4,00	47500	84	162	142
THT-100-6/12T-5,5	1165/575		11,30/4,20	4,00/0,65	47500/22100	84/69	162	142
THT-100-8T-2	850	7,80	4,50	1,50	32550	77	124	105
THT-100-8T-3	850	11,40	6,60	2,20	37450	77	142	122
THT-100-8T-4	850	15,60	9,00	3,00	43400	78	162	142
THT-125-4T/3-10	1750		17,70	7,50	54400	88	243	210
THT-125-4/8T/3-9	1745/870		15,60/6,30	6,70/1,50	50550/25000	88/68	243	210
THT-125-4T/3-15	1750		22,00	11,00	69800	89	294	266
THT-125-4/8T/3-15	1765/870		23,20/8,70	11,00/2,80	69800/34500	89/69	294	266
THT-125-4T/3-20	1750		29,00	15,00	77500	91	309	281

Características técnicas

Modelo	Velocidad (r/min)	Intensidad máxima admisible (A)		Potencia instalada (kW)	Caudal máximo (m³/h)	Nivel presión sonora dB(A)	Peso aprox. (Kg)	
		220-277V	380-480V				Larga	Corta
THT-125-4/8T/3-20	1765/870		31,70/11,80	15,00/3,80	77500/38300	91/71	309	281
THT-125-4T/3-25	1760		37,00	18,50	92950	91	377	334
THT-125-4T/3-30	1765		42,00	22,00	101300	92	391	348
THT-125-4/8T/3-27	1765/880		38,00/13,00	20,00/4,00	92950/45950	92/71	391	348
THT-125-4/8T/3-37	1770/880		51,00/20,60	27,00/6,00	118000/58350	93/72	472	429
THT-125-4T/3-40	1770		58,00	30,00	118000	93	472	429
THT-125-4/8T/3-40	1775/880		62,00/27,00	30,00/10,00	118000/58350	93/72	618	562
THT-125-4T/6-20	1750		29,00	15,00	69250	89	318	290
THT-125-4/8T/6-20	1765/870		31,70/11,80	15,00/3,80	73400/36250	89/68	318	290
THT-125-4/8T/6-22	1765/880		31,80/12,00	16,50/3,30	77500/38300	89/69	303	275
THT-125-4T/6-25	1760		37,00	18,50	81600	90	386	343
THT-125-4/8T/6-27	1765/880		38,00/13,00	20,00/4,00	85750/42350	90/69	400	357
THT-125-4T/6-30	1765		42,00	22,00	93950	90	400	357
THT-125-4/8T/6-37	1770/880		51,00/20,60	27,00/6,00	102200/50500	90/70	481	437
THT-125-4T/6-40	1770		58,00	30,00	110400	92	481	437
THT-125-4/8T/6-40	1775/880		62,00/27,00	30,00/10,00	110400/54600	92/71	627	571
THT-125-4T/6-50	1775		73,00	37,00	117700	93	529	473
THT-125-4T/9-25	1760		37,00	18,50	69850	88	395	352
THT-125-4/8T/9-22	1765/880		31,80/12,00	16,50/3,30	59500/29400	88/69	312	284
THT-125-4T/9-30	1765		42,00	22,00	85350	89	409	366
THT-125-4/8T/9-27	1765/880		38,00/13,00	20,00/4,00	75000	89/70	409	366
THT-125-4/8T/9-37	1770/880		51,00/20,60	27,00/6,00	85350/42200	90/70	490	446
THT-125-4T/9-40	1770		58,00	30,00	95700	91	490	446
THT-125-4/8T/9-40	1775/880		62,00/27,00	30,00/10,00	95700/47300	91/71	636	580
THT-125-4T/9-50	1775		73,00	37,00	106050	93	538	482
THT-125-6T/3-4	1165	13,50	7,80	3,00	35650	79	230	197
THT-125-6/12T/3-4	1150/570		8,90/3,50	3,00/0,55	40700/18900	79/64	232	199
THT-125-6T/3-5,5	1165		11,00	4,00	50800	80	242	209
THT-125-6/12T/3-5,5	1165/575		11,30/4,20	4,00/0,65	50800/23600	80/65	243	210
THT-125-6T/3-7,5	1165		12,40	5,50	60900	81	249	216
THT-125-6/12T/3-7,5	1165/575		13,20/5,30	5,50/1,00	60900/28300	81/66	263	230
THT-125-6T/3-10	1165		17,00	7,50	71850	83	274	246
THT-125-6/12T/3-10	1150/565		20,00/9,00	7,50/1,40	71850/33400	83/68	294	266
THT-125-6T/3-15	1145		26,00	11,00	91650	84	304	276
THT-125-6/12T/3-15	1150/565		28,50/13,00	11,00/2,00	91650/42600	84/69	309	281
THT-125-6T/3-20	1170		31,00	15,00	101650	85	377	334
THT-125-6/12T/3-24	1165/575		36,00/14,50	17,50/3,50	104450/48550	85/70	472	429
THT-125-6T/6-5,5	1165		11,00	4,00	45400	77	251	218
THT-125-6/12T/6-5,5	1165/575		11,30/4,20	4,00/0,65	50750/23600	77/62	252	219
THT-125-6T/6-7,5	1165		12,40	5,50	56150	77	258	225
THT-125-6/12T/6-7,5	1165/575		13,20/5,30	5,50/1,00	56150/26100	77/62	272	239
THT-125-6T/6-10	1165		17,00	7,50	66950	79	283	255
THT-125-6/12T/6-10	1150/565		20,00/9,00	7,50/1,40	66950/31150	79/64	303	275
THT-125-6T/6-15	1145		26,00	11,00	81900	81	313	285
THT-125-6/12T/6-15	1150/565		28,50/13,00	11,00/2,00	81900/38100	81/66	318	290
THT-125-6T/6-20	1170		31,00	15,00	91950	82	386	343
THT-125-6/12T/6-24	1165/575		36,00/14,50	17,50/3,50	102550/47700	82/67	481	437
THT-125-6T/9-10	1165		17,00	7,50	55900	78	292	264
THT-125-6/12T/9-10	1150/565		20,00/9,00	7,50/1,40	55900/26000	78/63	312	284
THT-125-6T/9-15	1145		26,00	11,00	76250	81	322	294
THT-125-6/12T/9-15	1150/565		28,50/13,00	11,00/2,00	76250/35450	81/66	327	299
THT-125-6T/9-20	1170		31,00	15,00	87450	84	395	352
THT-125-6/12T/9-24	1165/575		36,00/14,50	17,50/3,50	93050/43250	84/69	490	446
THT-140-6T/3-5,5	1130		8,72	4,00	47700	83	279	242
THT-140-6T/3-7,5	1150		12,20	5,50	61200	84	287	250
THT-140-6T/3-10	1165		15,60	7,50	67950	85	339	300
THT-140-6T/3-15	1165		23,30	11,00	88800	86	356	317
THT-140-6T/3-20	1165		27,40	15,00	103450	88	436	386

Características técnicas

Modelo	Velocidad (r/min)	Intensidad máxima admisible (A)		Potencia instalada (kW)	Caudal máximo (m³/h)	Nivel presión sonora dB(A)	Peso aprox. (Kg)	
		220-277V	380-480V				Larga	Corta
THT-140-6T/6-7,5	1150		12,20	5,50	60700	84	297	260
THT-140-6T/6-10	1165		15,60	7,50	67950	85	349	310
THT-140-6T/6-15	1165		23,30	11,00	82350	86	366	327
THT-140-6T/6-20	1165		27,40	15,00	96800	87	445	396
THT-140-6T/6-25	1170		34,40	18,50	103200	88	497	448
THT-140-6T/6-30	1170		41,40	22,00	116000	89	506	457
THT-140-6T/9-10	1165		15,60	7,50	56700	84	358	319
THT-140-6T/9-15	1165		23,30	11,00	74850	86	375	336
THT-140-6T/9-20	1165		27,40	15,00	83900	87	455	405
THT-140-6T/9-25	1170		34,40	18,50	102050	88	506	458
THT-140-6T/9-30	1170		41,40	22,00	109500	89	515	467
THT-140-6T/9-40	1180		54,20	30,00	124500	91	673	611
THT-140-6T/9-50	1175		66,40	37,00	133300	92	751	696
THT-140-8T/3-3	860	9,17	5,27	2,20	41050	78	279	242
THT-140-8T/3-4	850	12,50	7,20	3,00	51250	78	287	250
THT-140-8T/3-5,5	875		10,40	4,00	61450	79	337	298
THT-140-8T/3-7,5	875		13,80	5,50	72500	81	346	307
THT-140-8T/3-10	870		17,80	7,50	87700	82	357	318
THT-140-8T/6-3	860	9,17	5,27	2,20	45800	78	289	252
THT-140-8T/6-4	850	12,50	7,20	3,00	51250	79	297	260
THT-140-8T/6-5,5	875		10,40	4,00	56700	80	347	308
THT-140-8T/6-7,5	875		13,80	5,50	67600	81	356	317
THT-140-8T/6-10	870		17,80	7,50	77850	82	367	328
THT-140-8T/6-15	870		21,70	11,00	92850	83	453	404
THT-140-8T/9-4	850	12,50	7,20	3,00	42750	79	306	269
THT-140-8T/9-5,5	875		10,40	4,00	49600	79	356	317
THT-140-8T/9-7,5	875		13,80	5,50	56450	81	365	326
THT-140-8T/9-10	870		17,80	7,50	70150	82	376	337
THT-140-8T/9-15	870		21,70	11,00	82600	83	463	413
THT-140-8T/9-20	870		32,90	15,00	100550	86	516	468
THT-160-6T/3-10	1165		15,60	7,50	71150	83	412	358
THT-160-6T/3-15	1165		23,30	11,00	91350	85	429	375
THT-160-6T/3-20	1165		27,40	15,00	101450	86	522	453
THT-160-6T/3-25	1170		34,40	18,50	121600	87	574	504
THT-160-6T/3-30	1170		41,40	22,00	132550	89	583	513
THT-160-6T/6-15	1165		23,30	11,00	90650	85	440	386
THT-160-6T/6-20	1165		27,40	15,00	101400	86	532	463
THT-160-6T/6-25	1170		34,40	18,50	112200	87	584	515
THT-160-6T/6-30	1170		41,40	22,00	122950	88	593	524
THT-160-6T/6-40	1180		54,20	30,00	144500	89	768	669
THT-160-6T/6-50	1175		66,40	37,00	163600	91	842	757
THT-160-6T/9-15	1165		23,30	11,00	71100	85	450	396
THT-160-6T/9-20	1165		27,40	15,00	84600	86	542	473
THT-160-6T/9-25	1170		34,40	18,50	98150	87	594	525
THT-160-6T/9-30	1170		41,40	22,00	111700	88	603	534
THT-160-6T/9-40	1180		54,20	30,00	125250	89	778	679
THT-160-6T/9-50	1175		66,40	37,00	152300	90	852	768
THT-160-6T/9-60	1180		84,50	45,00	163500	91	1067	968
THT-160-6T/9-75	1180		100,00	55,00	174650	92	1112	1013
THT-160-8T/3-4	850	12,50	7,20	3,00	53700	77	356	304
THT-160-8T/3-5,5	875		10,40	4,00	61300	79	410	356
THT-160-8T/3-7,5	875		13,80	5,50	68900	80	419	365
THT-160-8T/3-10	870		17,80	7,50	84150	81	430	376
THT-160-8T/3-15	870		21,70	11,00	108250	83	530	461
THT-160-8T/6-5,5	875		10,40	4,00	68350	77	421	367
THT-160-8T/6-7,5	875		13,80	5,50	76500	79	430	376
THT-160-8T/6-10	870		17,80	7,50	84650	80	441	387
THT-160-8T/6-15	870		21,70	11,00	100900	82	540	471

Características técnicas

Modelo	Velocidad (r/min)	Intensidad máxima admisible (A)		Potencia instalada (kW)	Caudal máximo (m³/h)	Nivel presión sonora dB(A)	Peso aprox. (Kg)	
		220-277V	380-480V				Larga	Corta
THT-160-8T/6-20	870		32,90	15,00	116200	83	594	525
THT-160-8T/6-25	875		34,90	18,50	130600	84	741	642
THT-160-8T/9-7,5	875		13,80	5,50	63850	79	440	386
THT-160-8T/9-10	870		17,80	7,50	74050	80	451	397
THT-160-8T/9-15	870		21,70	11,00	84250	82	550	481
THT-160-8T/9-20	870		32,90	15,00	104700	83	604	535
THT-160-8T/9-25	875		34,90	18,50	114900	84	751	652
THT-160-8T/9-30	875		41,10	22,00	131750	85	776	677
THT-160-8T/9-40	875		56,30	30,00	150100	86	837	753

Características acústicas

Los valores indicados, se determinan mediante medidas de nivel de presión y potencia sonora en dB(A) obtenidas en campo libre a una distancia equivalente a dos veces la envergadura del ventilador más el diámetro de la hélice, con un mínimo de 1,5 mts.

Espectro de potencia sonora Lw(A) en dB(A) por banda de frecuencia en Hz

Modelo	63	125	250	500	1000	2000	4000	8000	Modelo	63	125	250	500	1000	2000	4000	8000
40-2-1,5	48	69	76	81	84	80	73	62	71-12-0,75	29	44	52	57	59	56	49	38
40-2-2	49	70	77	82	85	81	74	63	71-12-1	30	46	54	59	61	58	51	40
40-4-0,75	36	57	64	69	72	68	61	50	71-12-1,5	31	46	54	59	61	58	51	40
40-4-1,5	33	54	61	66	69	65	58	47	80-4-3	57	77	85	90	92	89	82	73
40-4-2	34	55	62	67	70	66	59	48	80-4-4	56	76	84	89	91	88	81	74
40-6	25	46	53	58	61	57	50	39	80-4-5,5	56	76	84	89	91	88	81	70
40-12	10	31	38	43	46	42	35	24	80-6-1,5	49	66	74	79	81	78	71	60
45-2-2	50	71	78	83	86	82	75	64	80-6-2	50	67	75	80	82	79	72	61
45-2-3	52	73	80	85	88	84	77	66	80-6-3	51	68	76	81	83	80	73	62
45-4-0,75	40	61	68	73	76	72	65	54	80-8-0,75	47	60	68	73	75	72	65	54
45-4-2	35	56	63	68	71	67	60	49	80-8-1	48	61	69	74	76	73	66	55
45-4-3	37	58	65	70	73	69	62	51	80-8-3	42	62	70	75	77	74	67	58
45-6	27	48	55	60	63	59	52	41	80-8-4	41	61	69	74	76	73	66	59
45-12	12	33	40	45	48	44	37	26	80-8-5,5	40	60	68	73	75	72	65	59
50-2-4	57	77	85	90	92	89	82	71	80-12-1,5	34	49	57	62	64	61	54	43
50-2-5,5	58	78	86	91	93	90	83	72	80-12-2	35	50	58	63	65	62	55	44
50-2-6	58	78	86	91	93	90	83	72	80-12-3	36	51	59	64	66	63	56	45
50-4-1	44	64	72	77	79	76	69	58	90-4-4	61	82	89	94	97	93	86	79
50-4-4	42	62	70	75	77	74	67	56	90-4-5,5	60	81	88	93	96	92	85	74
50-4-6	43	63	71	76	78	75	68	57	90-4-7,5	59	80	87	92	95	91	84	73
50-6	32	52	60	65	67	64	57	46	90-4-9	58	79	86	91	94	90	83	72
50-12	17	37	45	50	52	49	42	31	90-4-10	58	79	86	91	94	90	83	72
50-2-5,5	63	83	91	96	98	95	88	77	90-6-2	49	70	77	82	85	81	74	63
56-2-6	63	83	91	96	98	95	88	77	90-6-3	56	70	77	82	85	81	74	63
56-2-12	64	84	92	97	99	96	89	78	90-6-4	57	72	79	84	87	83	76	65
56-4-1	48	68	76	81	83	80	73	62	90-8-1	42	63	70	75	78	74	67	56
56-4-1,5	49	69	77	82	84	81	74	63	90-8-2	51	66	73	78	81	77	70	59
56-4-2	50	70	78	83	85	82	75	64	90-8-3	52	66	73	78	81	77	70	59
56-4-6	48	68	76	81	83	80	73	62	90-8-4	46	67	74	79	82	78	71	64
56-4-12	49	69	77	82	84	81	74	63	90-8-5,5	45	66	73	78	81	77	70	59
56-6	37	57	65	70	72	69	62	51	90-8-7,5	43	64	71	76	79	75	68	57
56-8-1,5	34	54	62	67	69	66	59	48	90-8-9	43	64	71	76	79	75	68	57
56-8-2	35	55	63	68	70	67	60	49	90-12-2	32	53	60	65	68	64	57	46
56-12	22	42	50	55	57	54	47	36	90-12-3	41	53	60	65	68	64	57	46
63-2-12	67	87	95	100	102	99	92	81	90-12-4	42	55	62	67	70	66	59	48
63-2-22	68	88	96	101	103	100	93	82	100-4-7,5	64	84	92	97	99	96	89	78
63-4-1	50	70	78	83	85	82	75	64	100-4-9	63	83	91	96	98	95	88	77
63-4-1,5	48	68	76	81	83	80	73	65	100-4-10	62	82	90	95	97	94	87	76
63-4-2	52	68	76	81	83	80	73	66	100-4-15	61	81	89	94	96	93	86	75
63-4-3	53	70	78	83	85	82	77	67	100-4-20	63	83	91	96	98	95	88	77
63-4-4	54	71	79	84	86	83	78	68	100-6-3	61	72	80	85	87	84	77	66
63-4-12	52	72	80	85	87	84	77	66	100-6-4	64	72	80	85	87	84	77	66
63-4-22	53	73	81	86	88	85	78	67	100-6-5,5	64	73	81	86	88	85	78	67
63-6-0,75	42	60	68	73	75	72	65	56	100-8-2	56	66	74	79	81	78	71	60
63-6-1	43	62	70	75	77	74	67	57	100-8-3	57	68	76	81	83	80	73	62
63-8-1,5	33	53	61	66	68	65	58	50	100-8-4	58	68	76	81	83	80	73	62
63-8-2	37	53	61	66	68	65	58	51	100-8-7,5	49	69	77	82	84	81	74	63
63-8-3	38	55	63	68	70	67	62	52	100-8-9	48	68	76	81	83	80	73	62
63-8-4	39	56	64	69	71	68	63	53	100-8-15	46	66	74	79	81	78	71	60
63-12-0,75	27	43	51	56	58	55	48	37	100-8-20	47	67	75	80	82	79	72	61
63-12-1	28	45	53	58	60	57	50	42	100-12-3	46	55	63	68	70	67	60	49
71-4-1,5	54	74	82	87	89	86	79	69	100-12-4	48	55	63	68	70	67	60	49
71-4-2	53	73	81	86	88	85	78	70	100-12-5,5	49	56	64	69	71	68	61	50
71-4-3	58	72	80	85	87	84	77	71	125-4/3-9	70	76	88	98	98	94	86	82
71-4-4	59	73	81	86	88	85	78	72	125-4/3-10	70	76	88	98	98	94	86	82
71-6-0,75	44	63	72	74	76	73	66	55	125-4/3-15	71	77	89	99	99	95	87	83
71-6-1	45	65	73	75	77	74	67	56	125-4/3-20	73	79	91	101	101	97	89	85
71-6-1,5	46	66	71	76	78	75	68	57	125-4/3-25	73	79	91	101	101	97	89	85
71-8-1,5	38	58	66	71	73	70	63	54	125-4/3-27	74	80	92	102	102	98	90	86
71-8-2	38	58	66	71	73	70	63	55	125-4/3-30	74	80	92	102	102	98	90	86
71-8-3	43	57	65	70	72	69	62	56	125-4/3-37	75	81	93	103	103	99	91	87
71-8-4	44	58	66	71	73	70	63	57	125-4/3-40	75	81	93	103	103	99	91	87

Características acústicas

Espectro de potencia sonora Lw(A) en dB(A) por banda de frecuencia en Hz

Modelo	63	125	250	500	1000	2000	4000	8000	Modelo	63	125	250	500	1000	2000	4000	8000
125-6/3-5,5	66	74	86	90	88	83	74	70	140-6/6-10	69	84	93	95	92	86	78	74
125-6/3-7,5	67	75	87	91	89	84	75	71	140-6/6-15	70	85	94	96	93	87	79	75
125-6/3-10	69	77	89	93	91	86	77	73	140-6/6-20	71	86	95	97	94	88	80	76
125-6/3-15	70	78	90	94	92	87	78	74	140-6/6-25	72	87	96	98	95	89	81	77
125-6/3-20	71	79	91	95	93	88	79	75	140-6/6-30	73	88	97	99	96	90	82	78
125-6/3-24	71	79	91	95	93	88	79	75	140-6/9-10	66	84	93	92	91	87	78	73
125-8/3-9	50	56	68	78	78	74	66	62	140-6/9-15	68	86	95	94	93	89	80	75
125-8/3-15	51	57	69	79	79	75	67	63	140-6/9-20	69	87	96	95	94	90	81	76
125-8/3-20	53	59	71	81	81	77	69	65	140-6/9-25	70	88	97	96	95	91	82	77
125-8/3-27	53	59	71	81	81	77	69	65	140-6/9-30	71	89	98	97	96	92	83	78
125-8/3-37	54	60	72	82	82	78	70	66	140-6/9-40	73	91	100	99	98	94	85	80
125-8/3-40	54	60	72	82	82	78	70	66	140-6/9-50	74	92	101	100	99	95	86	81
125-6/3-4	65	73	85	89	87	82	73	69	140-8/3-3	64	74	82	87	86	85	72	67
125-12/3-4	50	58	70	74	72	67	58	54	140-8/3-4	64	74	82	87	86	85	72	67
125-12/3-5,5	51	59	71	75	73	68	59	55	140-8/3-5,5	65	75	83	88	87	86	73	68
125-12/3-7,5	52	60	72	76	74	69	60	56	140-8/3-7,5	67	77	85	90	89	88	75	70
125-12/3-10	54	62	74	78	76	71	62	58	140-8/3-10	68	78	86	91	90	89	76	71
125-12/3-15	55	63	75	79	77	72	63	59	140-8/6-3	63	75	84	88	86	80	70	67
125-12/3-24	56	64	76	80	78	73	64	60	140-8/6-4	64	76	85	89	87	81	71	68
125-4/6-20	67	75	91	98	100	95	89	85	140-8/6-5,5	65	77	86	90	88	82	72	69
125-4/6-22	67	75	91	98	100	95	89	85	140-8/6-7,5	66	78	87	91	89	83	73	70
125-4/6-25	68	76	92	99	101	96	90	86	140-8/6-10	67	79	88	92	90	84	74	71
125-4/6-27	68	76	92	99	101	96	90	86	140-8/6-15	68	80	89	93	91	85	75	72
125-4/6-30	68	76	92	99	101	96	90	86	140-8/9-4	62	73	84	89	87	83	73	68
125-4/6-37	68	76	92	99	101	96	90	86	140-8/9-5,5	62	73	84	89	87	83	73	68
125-4/6-40	70	78	94	101	103	98	92	88	140-8/9-7,5	64	75	86	91	89	85	75	70
125-4/6-50	71	79	95	102	104	99	93	89	140-8/9-10	65	76	87	92	90	86	76	71
125-6/6-5,5	60	69	82	85	86	83	72	68	140-8/9-15	66	77	88	93	91	87	77	72
125-6/6-7,5	60	69	82	85	86	83	72	68	140-8/9-20	69	80	91	96	94	90	80	75
125-6/6-10	62	71	84	87	88	85	74	70	160-6/3-10	69	79	87	92	91	90	77	72
125-6/6-15	64	73	86	89	90	87	76	72	160-6/3-15	71	81	89	94	93	92	79	74
125-6/6-20	65	74	87	90	91	88	77	73	160-6/3-20	72	82	90	95	94	93	80	75
125-6/6-24	65	74	87	90	91	88	77	73	160-6/3-25	73	83	91	96	95	94	81	76
125-8/6-20	46	54	70	77	79	74	68	64	160-6/3-30	75	85	93	98	97	96	83	78
125-8/6-22	47	55	71	78	80	75	69	65	160-6/6-15	69	84	93	95	92	86	78	74
125-8/6-27	47	55	71	78	80	75	69	65	160-6/6-20	70	85	94	96	93	87	79	75
125-8/6-37	48	56	72	79	81	76	70	66	160-6/6-25	71	86	95	97	94	88	80	76
125-8/6-40	49	57	73	80	82	77	71	67	160-6/6-30	72	87	96	98	95	89	81	77
125-12/6-5,5	45	54	67	70	71	68	57	53	160-6/6-40	73	88	97	99	96	90	82	78
125-12/6-7,5	45	54	67	70	71	68	57	53	160-6/6-50	75	90	99	101	98	92	84	80
125-12/6-10	47	56	69	72	73	70	59	55	160-6/9-15	67	85	94	93	92	88	79	74
125-12/6-15	49	58	71	74	75	72	61	57	160-6/9-20	68	86	95	94	93	89	80	75
125-12/6-24	50	59	72	75	76	73	62	58	160-6/9-25	69	87	96	95	94	90	81	76
125-4/9-22	66	74	91	97	98	93	88	84	160-6/9-30	70	88	97	96	95	91	82	77
125-4/9-25	66	74	91	97	98	93	88	84	160-6/9-40	71	89	98	97	96	92	83	78
125-4/9-27	67	75	92	98	99	94	89	85	160-6/9-50	72	90	99	98	97	93	84	79
125-4/9-30	67	75	92	98	99	94	89	85	160-6/9-60	73	91	100	99	98	94	85	80
125-4/9-37	68	76	93	99	100	95	90	86	160-6/9-75	74	92	101	100	99	95	86	81
125-4/9-40	69	77	94	100	101	96	91	87	160-8/3-4	63	73	81	86	85	84	71	66
125-4/9-50	71	79	96	102	103	98	93	89	160-8/3-5,5	65	75	83	88	87	86	73	68
125-6/9-10	58	68	83	87	86	85	74	70	160-8/3-7,5	66	76	84	89	88	87	74	69
125-6/9-15	61	71	86	90	89	88	77	73	160-8/3-10	67	77	85	90	89	88	75	70
125-6/9-20	64	74	89	93	92	91	80	76	160-8/3-15	69	79	87	92	91	90	77	72
125-6/9-24	64	74	89	93	92	91	80	76	160-8/6-5,5	61	76	85	87	84	78	70	66
125-8/9-22	47	55	72	78	79	74	69	65	160-8/6-7,5	63	78	87	89	86	80	72	68
125-8/9-27	48	56	73	79	80	75	70	66	160-8/6-10	64	79	88	90	87	81	73	69
125-8/9-37	48	56	73	79	80	75	70	66	160-8/6-15	66	81	90	92	89	83	75	71
125-8/9-40	49	57	74	80	81	76	71	67	160-8/6-20	67	82	91	93	90	84	76	72
125-12/9-10	43	53	68	72	71	70	59	55	160-8/6-25	68	83	92	94	91	85	77	73
125-12/9-15	46	56	71	75	74	73	62	58	160-8/9-7,5	61	79	88	87	86	82	73	68
125-12/9-24	49	59	74	78	77	76	65	61	160-8/9-10	62	80	89	88	87	83	74	69
140-6/3-5,5	69	79	87	92	91	90	77	77	160-8/9-15	64	82	91	90	89	85	76	71
140-6/3-7,5	70	80	88	93	92	91	78	78	160-8/9-20	65	83	92	91	90	86	77	72
140-6/3-10	71	81	89	94	93	92	79	79	160-8/9-25	66	84	93	92	91	87	78	73
140-6/3-15	72	82	90	95	94	93	80	80	160-8/9-30	67	85	94	93	92	88	79	74
140-6/3-20	74	84	92	97	96	95	82	82	160-8/9-40	68	86	95	94	93	89	80	75
140-6/6-7,5	68	83	92	94	91	85	77	73									

Accesorios



INT

IAT

CABLE BOX

C2V

AET

CENTRAL CO

VSD3/A-RFT

P-400

R

RI

Dimensiones mm

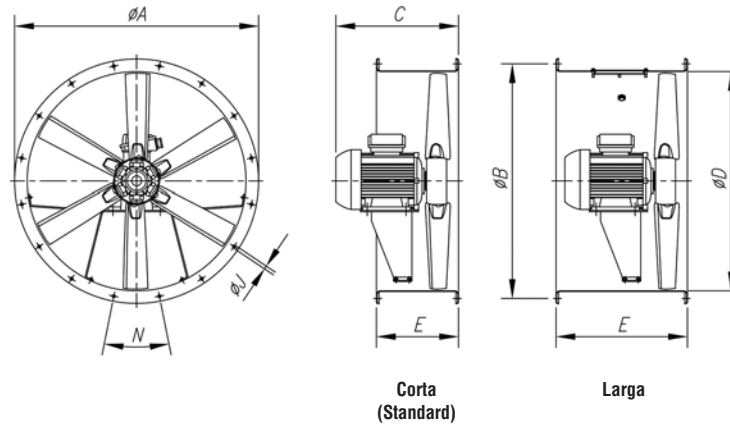

C (Consultar tamaño motor según potencia)

Modelo	ØA	ØB	C (Consultar tamaño motor según potencia)																ØD	E		ØJ	N
			80	90S	90L	100	112	132S	132M	132ML	160M	160L	180M	180L	200L	225	250	280		Corta	Larga		
THT-40	490	450	348	364	389	-	-	-	-	-	-	-	-	-	-	-	-	-	410	250	400	12	8x45°
THT-45	540	500	348	364	389	-	-	-	-	-	-	-	-	-	-	-	-	-	460	250	400	12	8x45°
THT-50	600	560	339	364	389	-	-	-	-	-	-	-	-	-	-	-	-	-	514	250	400	12	12x30°
THT-50	600	560	-	-	-	419	438	-	-	-	-	-	-	-	-	-	-	-	514	250	500	12	12x30°
THT-56	660	620	275	364	389	-	-	-	-	-	-	-	-	-	-	-	-	-	560	250	400	12	12x30°
THT-56	660	620	-	-	-	416	432	480	518	-	-	-	-	-	-	-	-	-	560	250	500	12	12x30°
THT-56	660	620	-	-	-	-	-	-	-	620	-	-	-	-	-	-	-	-	560	250	650	12	12x30°
THT-63	730	690	339	359	389	-	-	-	-	-	-	-	-	-	-	-	-	-	640	250	400	12	12x30°
THT-63	730	690	-	-	-	420	437	-	-	-	-	-	-	-	-	-	-	-	640	250	500	12	12x30°
THT-63	730	690	-	-	-	-	-	539	577	-	-	-	-	-	-	-	-	-	640	250	650	12	12x30°
THT-63	730	690	-	-	-	-	-	-	-	630	674	-	-	-	-	-	-	-	640	350	650	12	12x30°
THT-71	810	770	366	379	404	-	-	-	-	-	-	-	-	-	-	-	-	-	710	300	430	12	16x22°30'
THT-71	810	770	-	-	-	438	433	-	-	-	-	-	-	-	-	-	-	-	710	300	500	12	16x22°30'
THT-80	900	860	-	-	422	456	472	-	-	-	-	-	-	-	-	-	-	-	800	300	500	12	16x22°30'
THT-80	900	860	-	-	-	-	-	515	-	-	-	-	-	-	-	-	-	-	800	300	600	12	16x22°30'
THT-90	1015	970	-	-	-	466	482	525	565	590	-	-	-	-	-	-	-	-	900	350	600	15	16x22°30'
THT-100	1115	1070	-	-	-	-	482	525	565	590	-	-	-	-	-	-	-	-	1000	450	600	15	16x22°30'
THT-100	1115	1070	-	-	-	-	-	-	-	-	695	695	-	-	-	-	-	-	1000	450	700	15	16x22°30'
THT-125	1365	1320	-	-	-	-	-	561	601	-	-	-	-	-	-	-	-	-	1250	500	700	15	20x18°
THT-125	1365	1320	-	-	-	-	-	-	-	626	695	695	-	-	-	-	-	-	1250	500	700	15	20x18°
THT-125	1365	1320	-	-	-	-	-	-	-	-	-	740	740	860	-	-	-	-	1250	500	900	15	20x18°
THT-125	1365	1320	-	-	-	-	-	-	-	-	-	-	-	-	907	-	-	-	1250	500	1000	15	20x18°
THT-125	1365	1320	-	-	-	-	-	-	-	-	-	-	-	-	-	987	-	-	1250	600	1000	15	20x18°
THT-125	1365	1320	-	-	-	-	-	-	-	-	-	-	-	-	-	-	1077	-	1250	600	1200	15	20x18°
THT-140	1515	1470	-	-	-	-	532	570	-	-	-	-	-	-	-	-	-	-	1400	400	650	15	20x18°
THT-140	1515	1470	-	-	-	-	-	-	650	700	-	-	-	-	-	-	-	-	1400	450	700	15	20x18°
THT-140	1515	1470	-	-	-	-	-	-	-	-	-	-	765	-	-	-	-	-	1400	550	900	15	20x18°
THT-140	1515	1470	-	-	-	-	-	-	-	-	-	-	-	825	-	-	-	-	1400	550	900	15	20x18°
THT-140	1515	1470	-	-	-	-	-	-	-	-	-	-	-	-	910	-	-	-	1400	550	1000	15	20x18°
THT-140	1515	1470	-	-	-	-	-	-	-	-	-	-	-	-	-	985	-	-	1400	600	1000	15	20x18°
THT-160	1735	1680	-	-	-	-	532	570	-	-	-	-	-	-	-	-	-	-	1600	400	650	19	24x15°
THT-160	1735	1680	-	-	-	-	-	-	-	700	-	-	-	-	-	-	-	-	1600	450	700	19	24x15°
THT-160	1735	1680	-	-	-	-	-	-	-	-	-	765	-	-	-	-	-	-	1600	550	900	19	24x15°
THT-160	1735	1680	-	-	-	-	-	-	-	-	-	-	-	825	-	-	-	-	1600	550	1000	19	24x15°
THT-160	1735	1680	-	-	-	-	-	-	-	-	-	-	-	-	910	-	-	-	1600	550	1000	19	24x15°
THT-160	1735	1680	-	-	-	-	-	-	-	-	-	-	-	-	-	985	-	-	1600	600	1000	19	24x15°
THT-160	1735	1680	-	-	-	-	-	-	-	-	-	-	-	-	-	-	1190	-	1600	700	1000	19	24x15°

* Versión estándar suministrada en carcasa corta. Bajo demanda carcasa larga con trampilla de inspección.

Tamaños constructivos motores según potencia (1velocidad)

	CV																			
	0,75	1	1,5	2	3	4	5,5	7,5	10	12	15	20	22	25	30	40	50	60	75	100
2T (3000 r/min)	80	80	80	90S	90L	100LB	112M	132S	132S	132MA	160M	160M	160L	180M	180L	200L	225S/M	225S/M	250S/M	280S/M
4T (1500 r/min)	90S	90S	90S	90L	100LA	100LB	112M	132S	132M	-	160M	160L	-	180M	180L	200L	225S/M	225S/M	250S/M	280S/M
6T (1000 r/min)	90S	90S	90L	100L	112M	132S	132MA	132MB	160M	-	160L	180L	-	200MLA	200MLB	225SMB	250S/M	280S/M	280S/M	-
8T (750 r/min)	90L	100LA	100L	112M	132S	132M	160MA	160M	160L	-	180L	200MLA	-	225SMA	225SMB	250SMA	280S/M	280S/M	-	-

Tamaños constructivos motores según potencia (2velocidad)

	CV																						
	0,75	1	1,5	2	3	4	5,5	6	7,5	8	9	10	12	15	18	20	22	24	27	37	38	40	
2/4(3000/1500 r/min)	-	-	90S	90S	90L	100L	-	112M	-	-	132M	-	160MA	-	160M	-	160L	-	-	-	-	-	-
4/8(1500/750 r/min)	-	-	90S	100L	100LA	100LC	132S	-	132S	132S	-	132M	-	160M	-	160L	180M	180L	200MLA	200L	225S/M	-	
6/12(1000/500 r/min)	90L	100L	100LB	112M	112M	132MC	160M	160M	160LB	160LB	-	160LB	-	200MLC	160L	200M	-	250SMB	22S/M	-	225S/M	-	

EJEMPLO SELECCIÓN

Curvas características

THT CJTHT

Q= Caudal en m³/h, m³/s y cfm.Pe= Presión estática en mmH₂O, Pa e inwg.

Diámetro Hélice (cm): 71

Número de polos: 6

Número de palas: 6

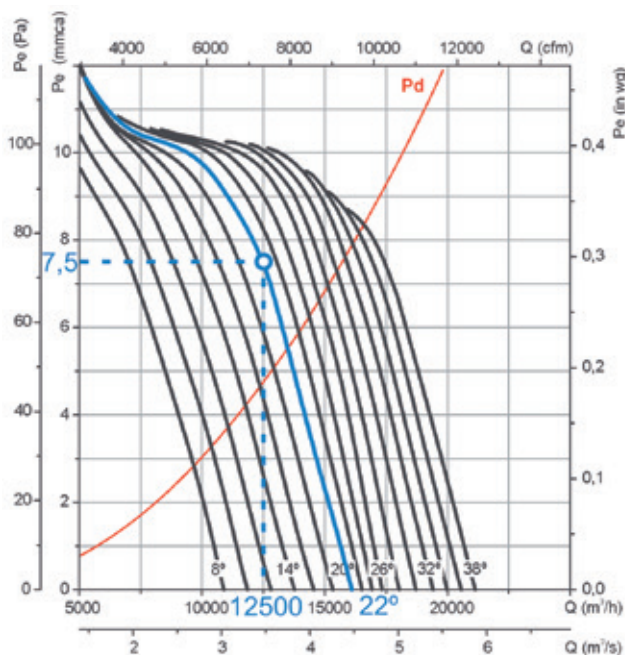

Datos de partida

- Punto de trabajo:
- Caudal: 12.500 m³/h
- Pérdida de carga: 7,5 mm c.a.

Pasos para la selección del equipo

En la gráfica de presiones:

1. Marcar el punto de trabajo, definido por el caudal de trabajo (12.500 m³/h) y la pérdida de carga (7,5 mmH₂O).
2. Escoger la curva del equipo que más se acerque por encima al punto de trabajo. En nuestro caso se obtiene una curva de 22° de ángulo de pala.

En la gráfica de potencia:

3. Marcar el punto de trabajo, definido por el caudal de trabajo (12.500 m³/h) y la curva de ángulo de pala escogido (22°).
4. Leer la potencia absorbida en el eje de potencias a la izquierda. La Pa= 560 W en el punto de trabajo.
5. Buscar recta roja que más se acerque al punto de trabajo por encima. En la parte derecha de la gráfica se obtiene el valor de potencia instalada de motor. En nuestro caso 0,75 kW o 1 CV.

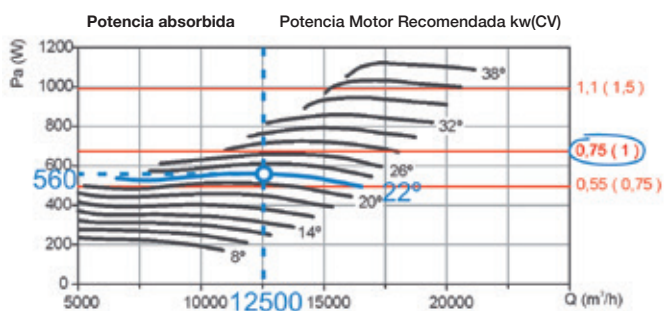

EJEMPLO CÓDIGO PEDIDO

	THT	40	4T	2	6-20	F-400
Nombre de serie:	THT	Diámetro hélice en cm.	Número de polos motor	T=Trifásico M=Monofásico	Potencia motor (c.v.)	Número de palas
CJTHT			2=3500 r/min. 60 Hz 4=1680 r/min. 60 Hz 6=1080 r/min. 60 Hz 8=900 r/min. 60 Hz 12=750 r/min. 60 Hz		3 palas 6 palas 9 palas	Angulo inclinación palas
						F-300: Homologación 300°C/2h F-400: Homologación 400°C/2h CAT3: Con certificación ATEX Categoría 3 Ex II3G

Curvas características

Q= Caudal en m³/h, m³/s y cfm.

Pe= Presión estática en mmH₂O, Pa e inwg.

Diámetro Hélice (cm): 40

Número de polos: 2

Número de palas: 6

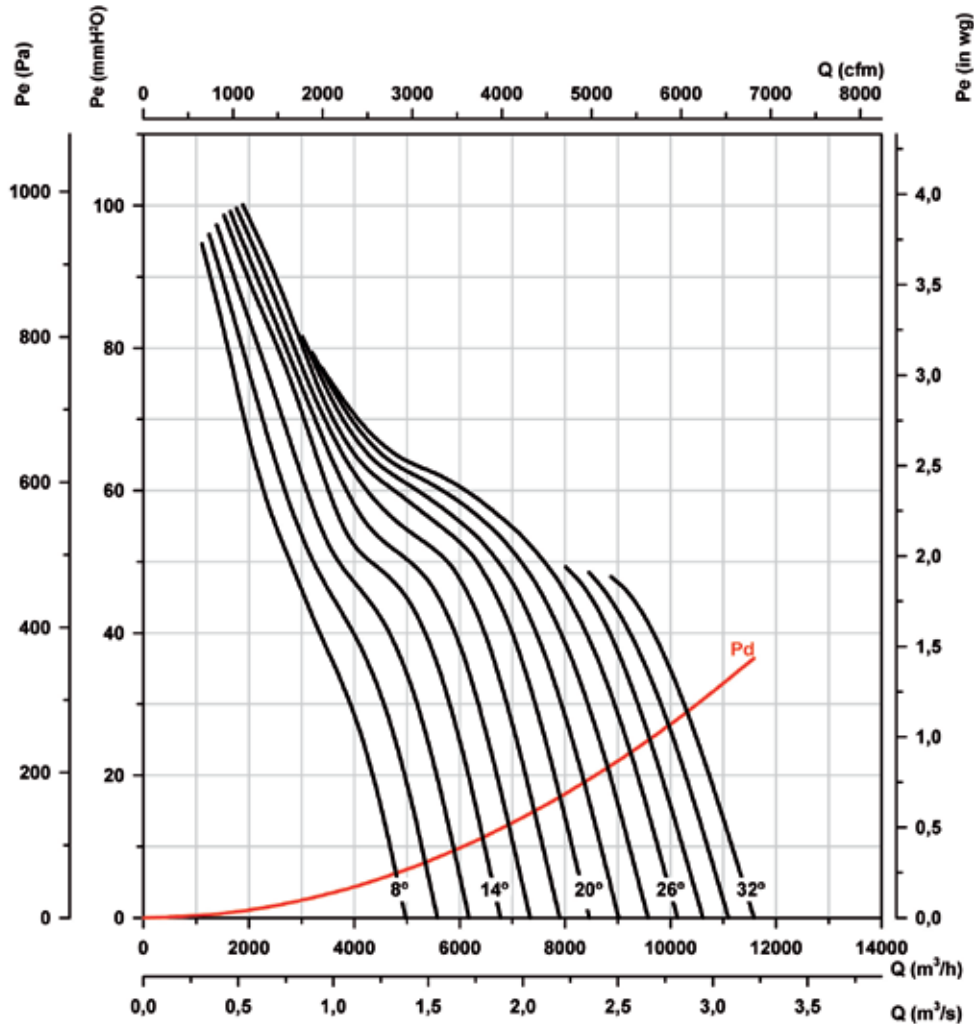

Potencia absorbida

Potencia Motor Recomendada kw(CV)

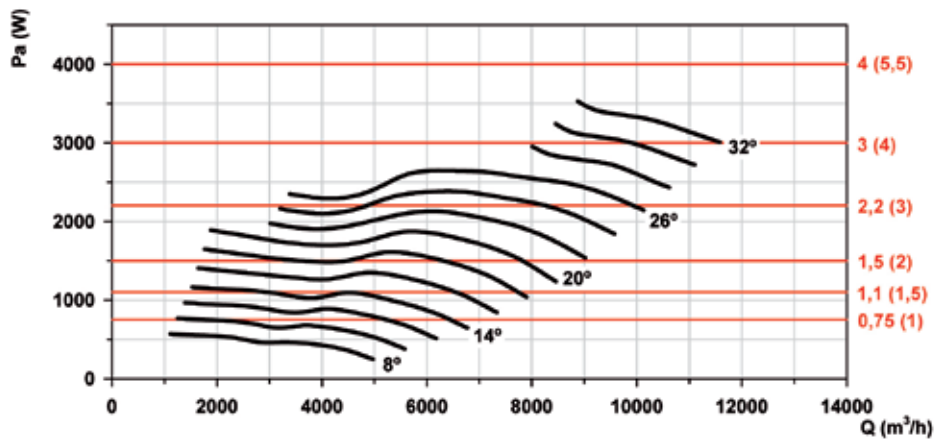

Curvas características

Q= Caudal en m³/h, m³/s y cfm.

Pe= Presión estática en mmH²O, Pa e inwg.

Diámetro Hélice (cm): 40

Número de polos: 4

Número de palas: 6

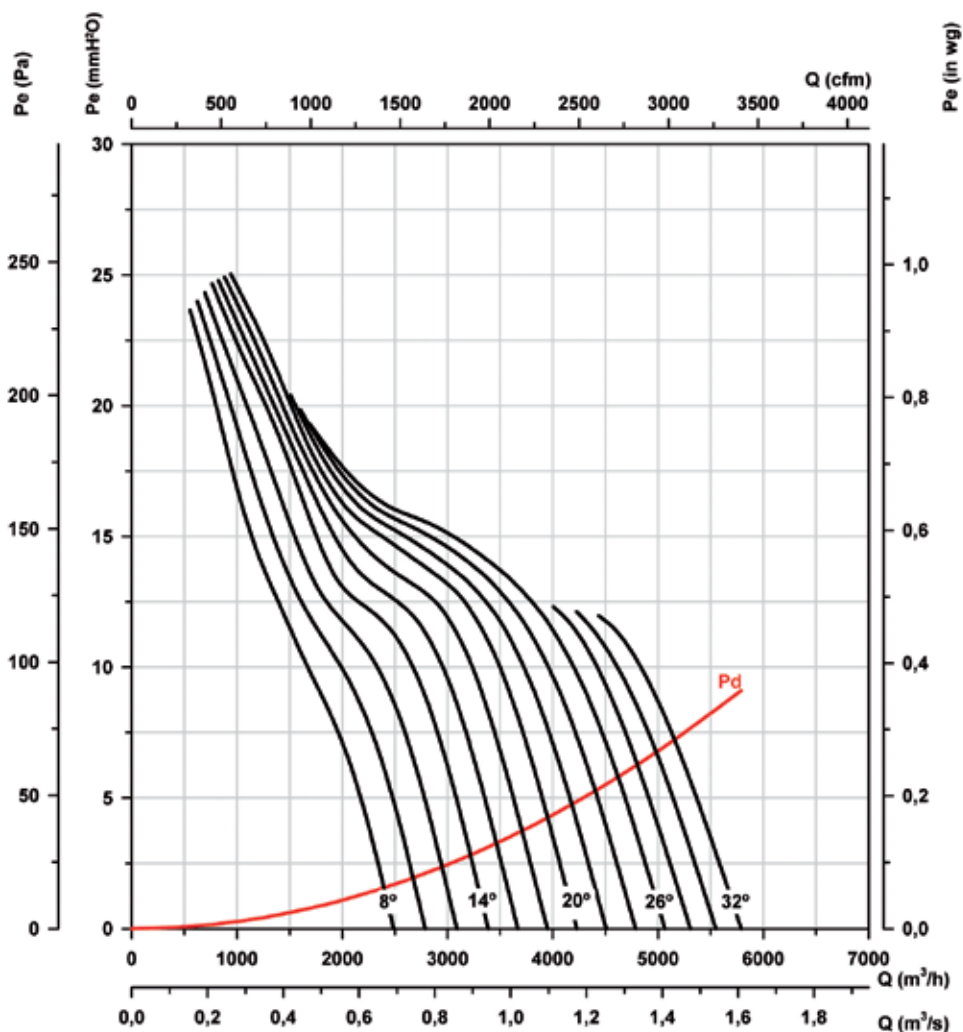

Potencia absorbida

Potencia Motor Recomendada kw(CV)

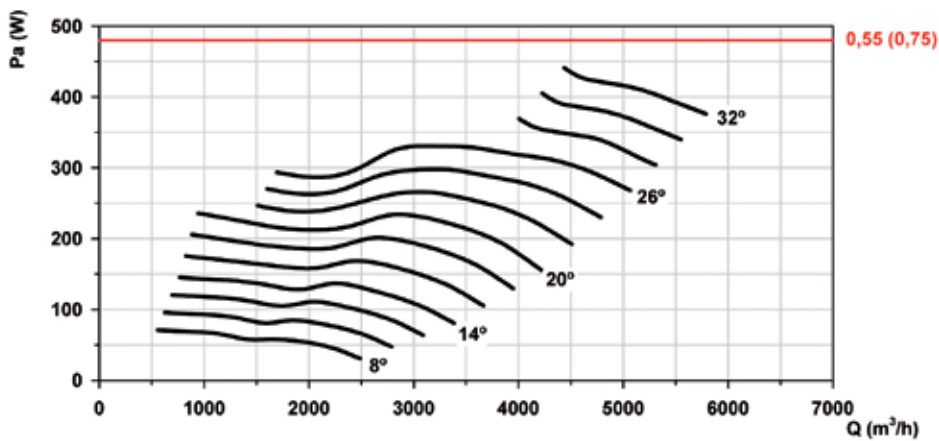

Curvas características

Q= Caudal en m³/h, m³/s y cfm.

Pe= Presión estática en mmH₂O, Pa e inwg.

Diámetro Hélice (cm): 40

Número de polos: 6

Número de palas: 6

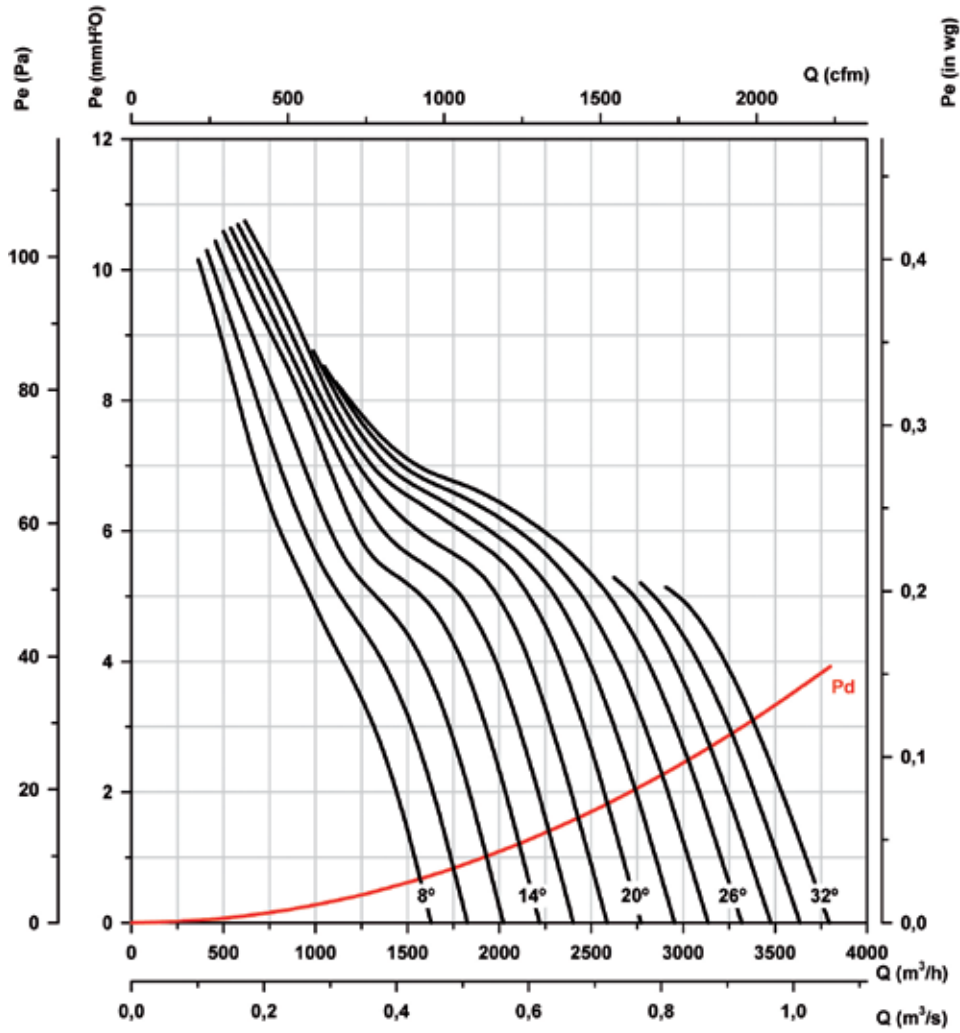

Potencia absorbida

Potencia Motor Recomendada kw(CV)

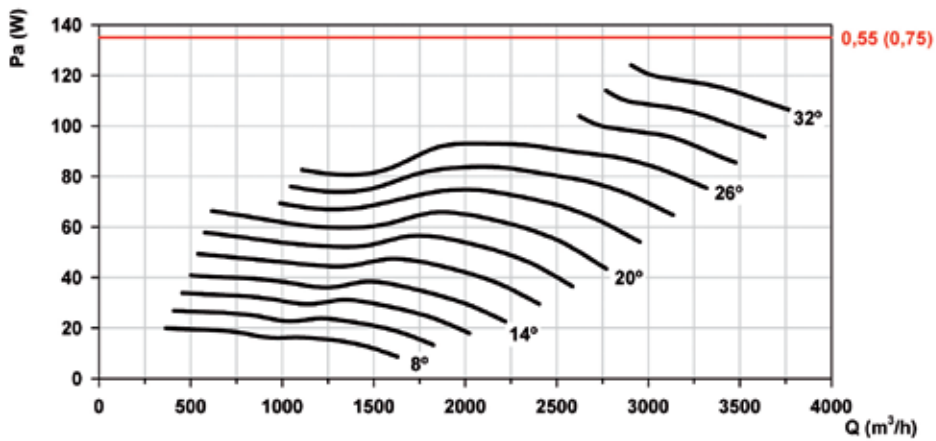

Curvas características

Q= Caudal en m³/h, m³/s y cfm.

Pe= Presión estática en mmH₂O, Pa e inwg.

Diámetro Hélice (cm): 45

Número de polos: 2

Número de palas: 6

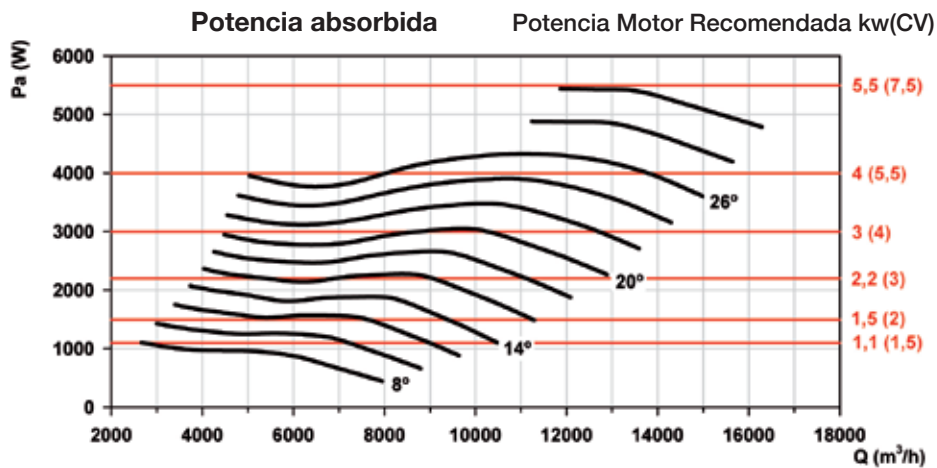
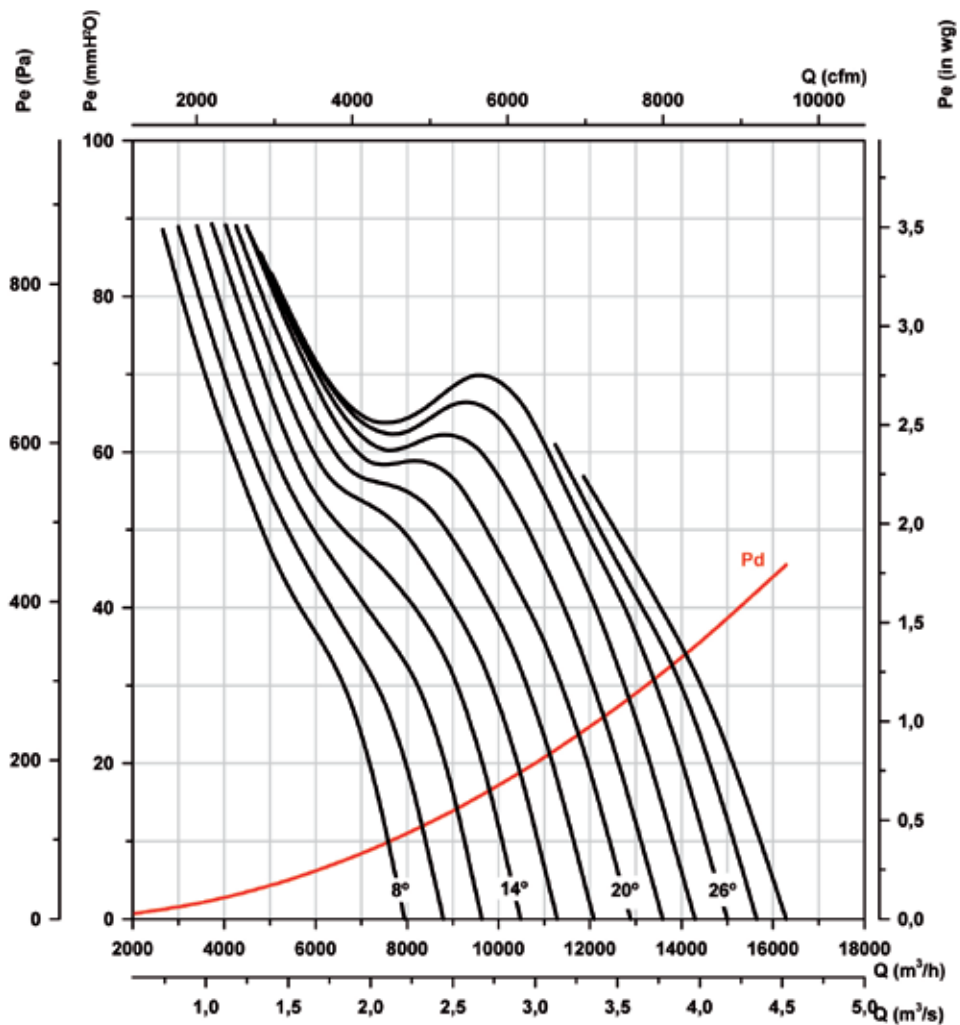

Curvas características

Q= Caudal en m³/h, m³/s y cfm.

Pe= Presión estática en mmH₂O, Pa e inwg.

Diámetro Hélice (cm): 45

Número de polos: 4

Número de palas: 6

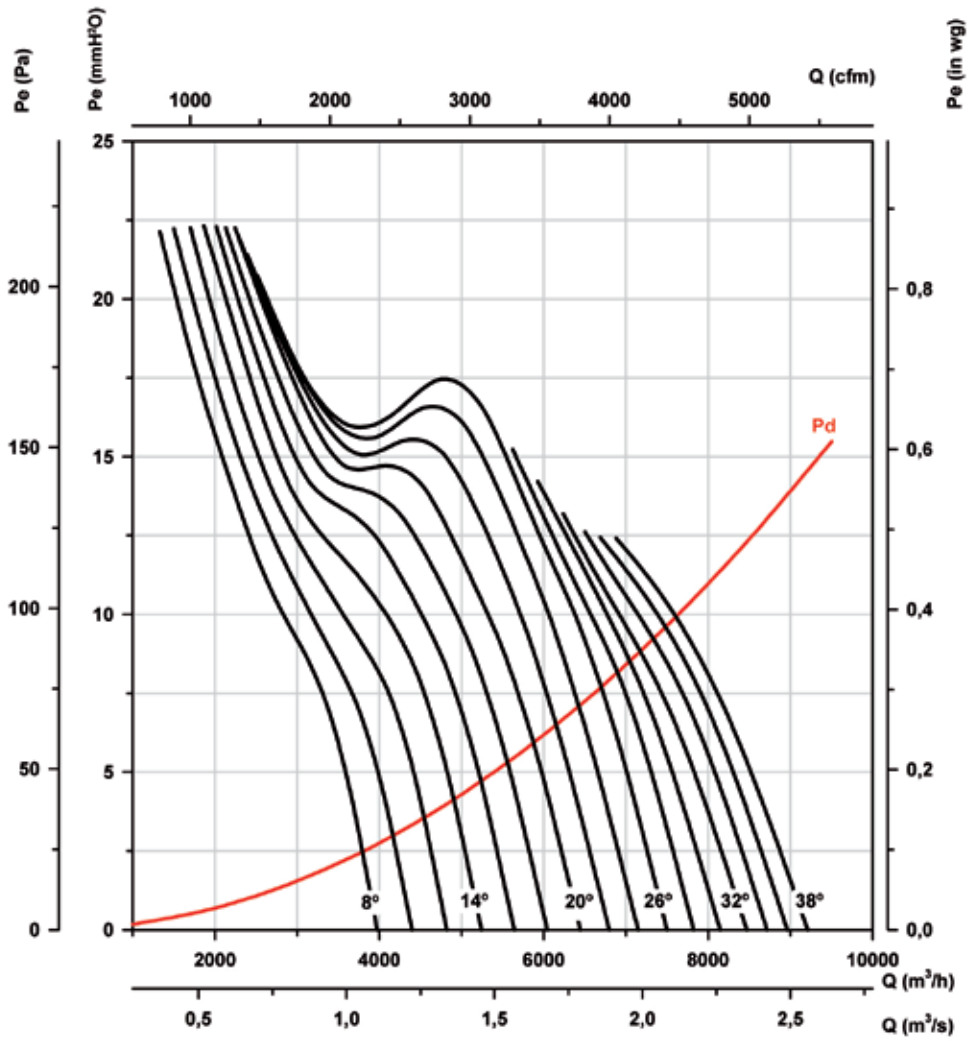

Potencia absorbida

Potencia Motor Recomendada kw(CV)

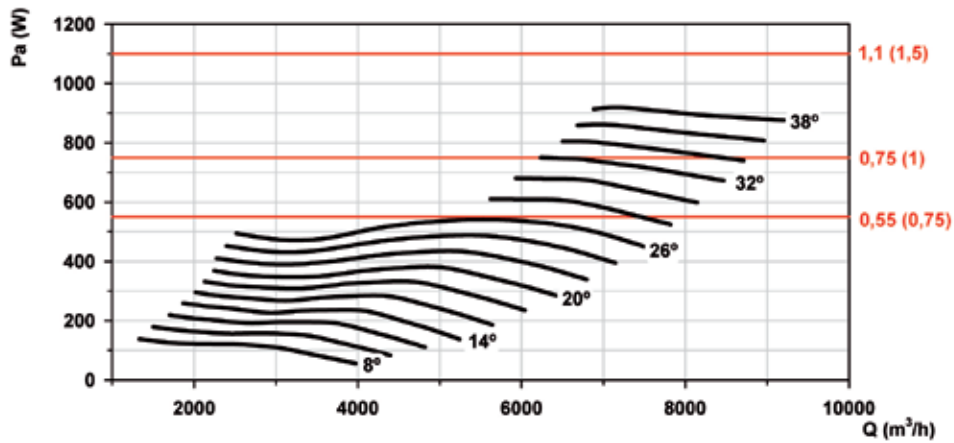

Curvas características

Q= Caudal en m³/h, m³/s y cfm.

Pe= Presión estática en mmH²O, Pa e inwg.

Diámetro Hélice (cm): 45

Número de polos: 6

Número de palas: 8

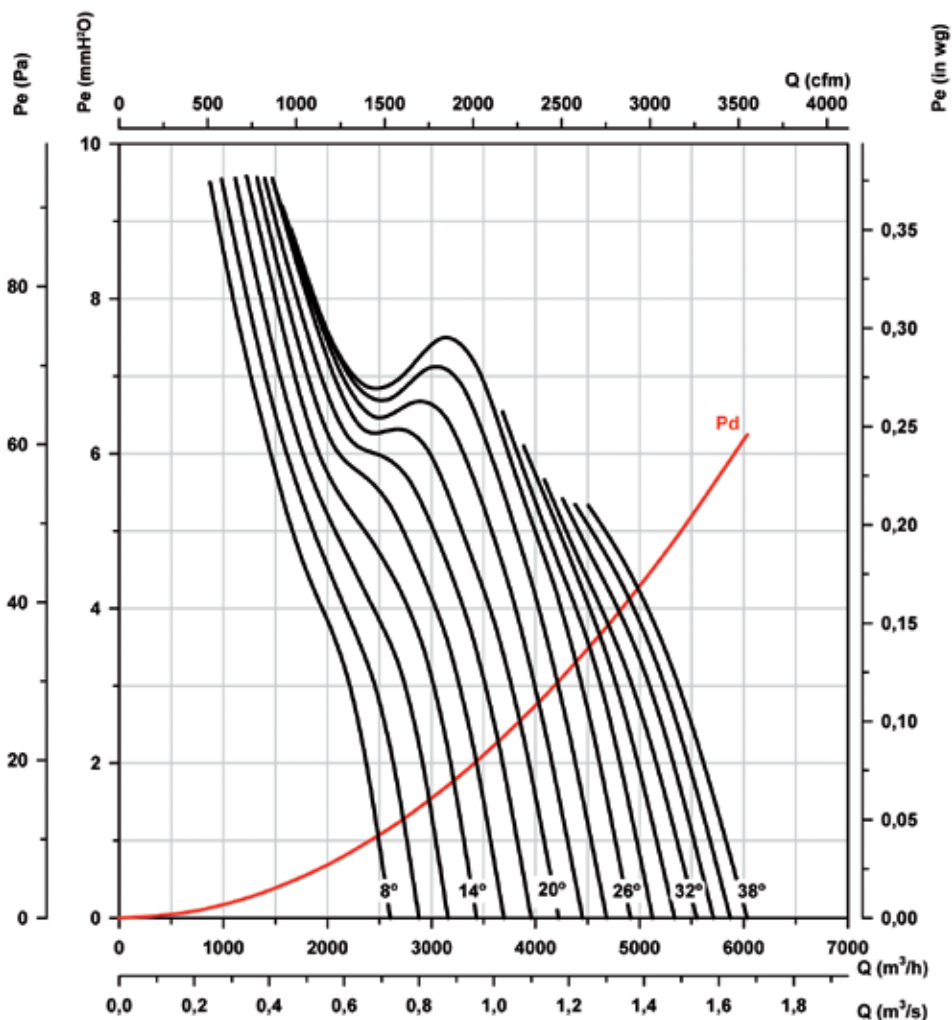

Potencia absorbida

Potencia Motor Recomendada kw(CV)

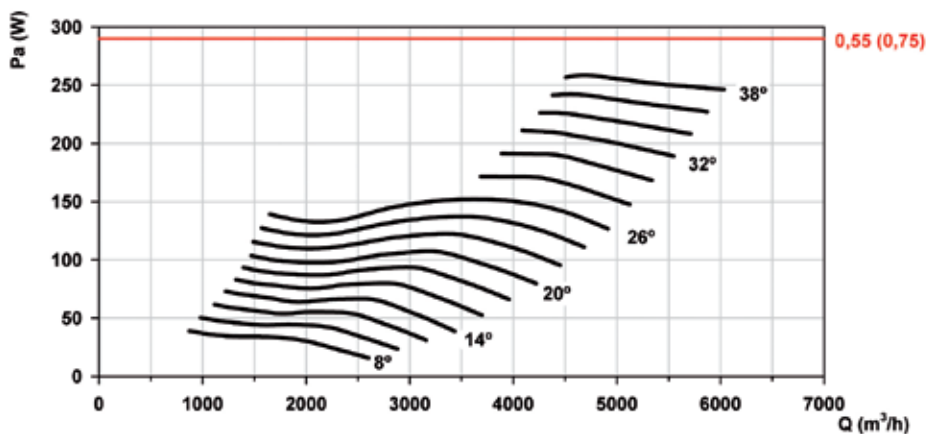

Curvas características

Q= Caudal en m³/h, m³/s y cfm.

Pe= Presión estática en mmH₂O, Pa e inwg.

Diámetro Hélice (cm): 50

Número de polos: 2

Número de palas: 6

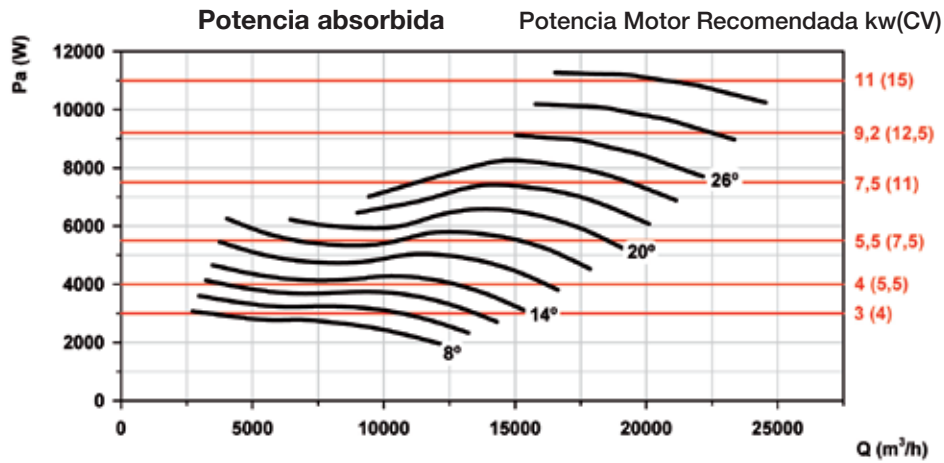
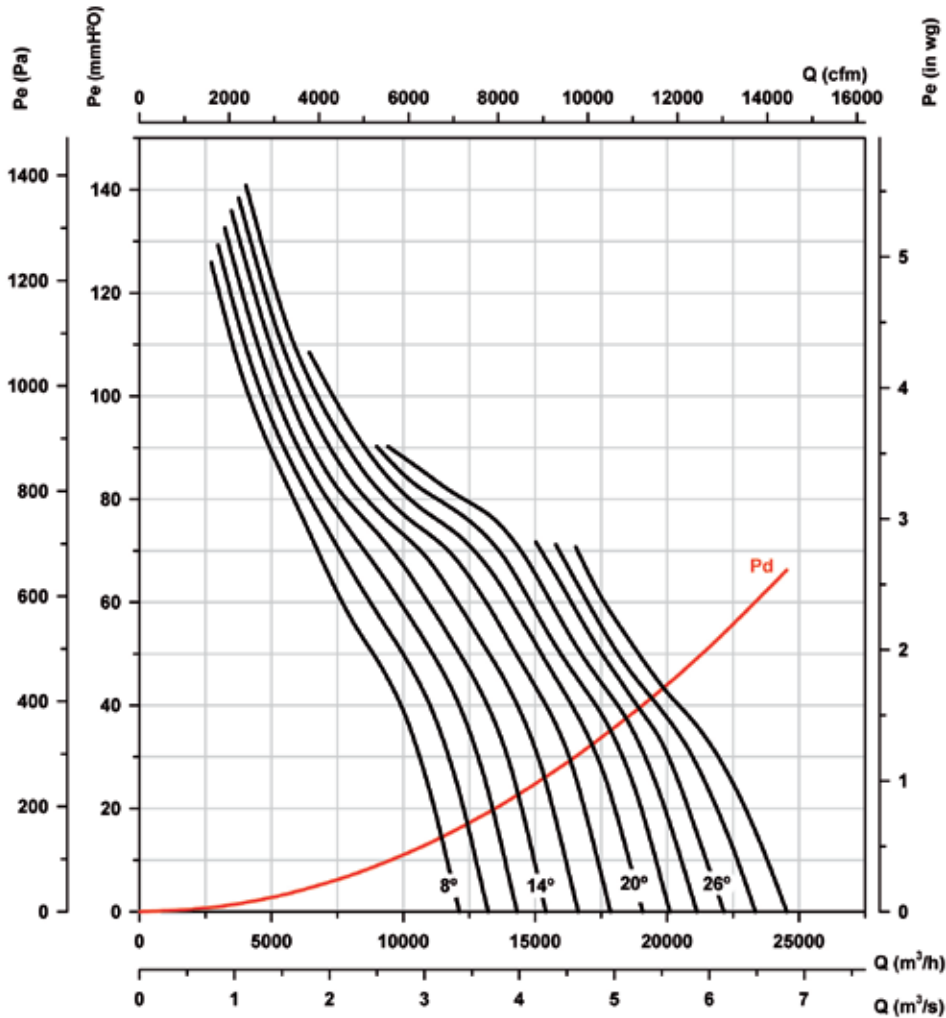

Curvas características

Q= Caudal en m³/h, m³/s y cfm.

Pe= Presión estática en mmH²O, Pa e inwg.

Diámetro Hélice (cm): 50

Número de polos: 4

Número de palas: 6

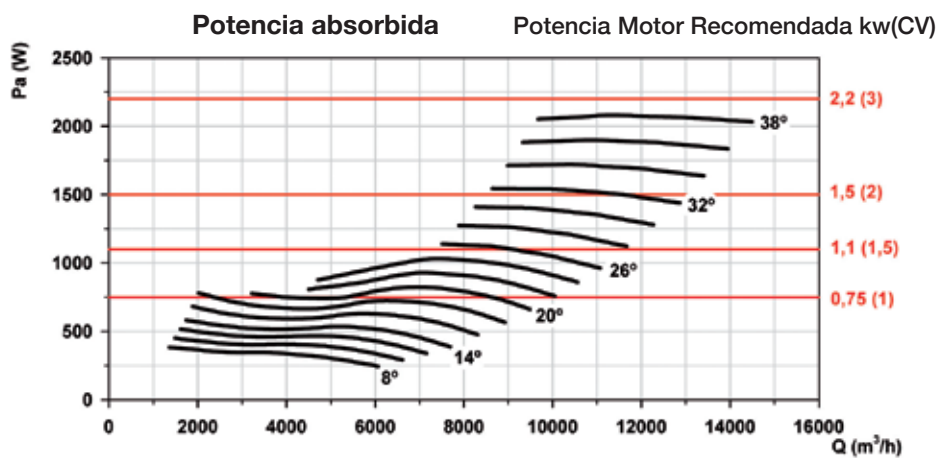
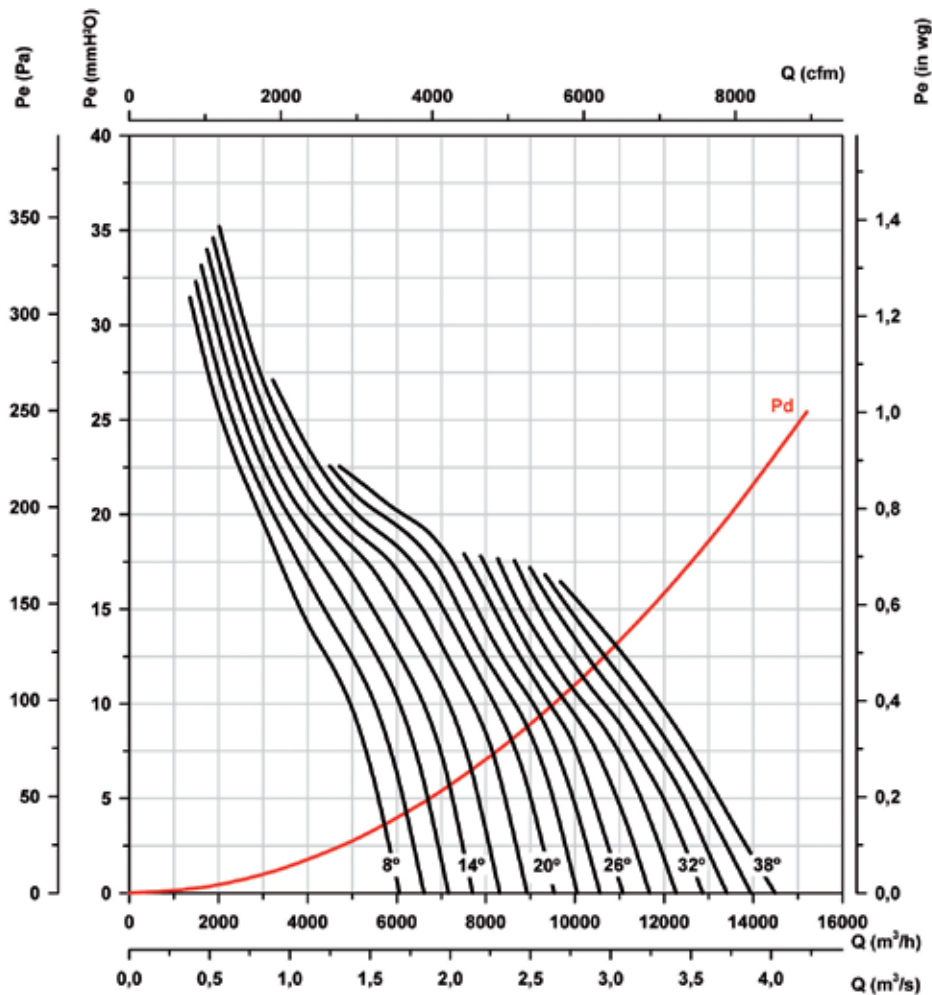

Curvas características

Q= Caudal en m³/h, m³/s y cfm.

Pe= Presión estática en mmH₂O, Pa e inwg.

Diámetro Hélice (cm): 50

Número de polos: 6

Número de palas: 6

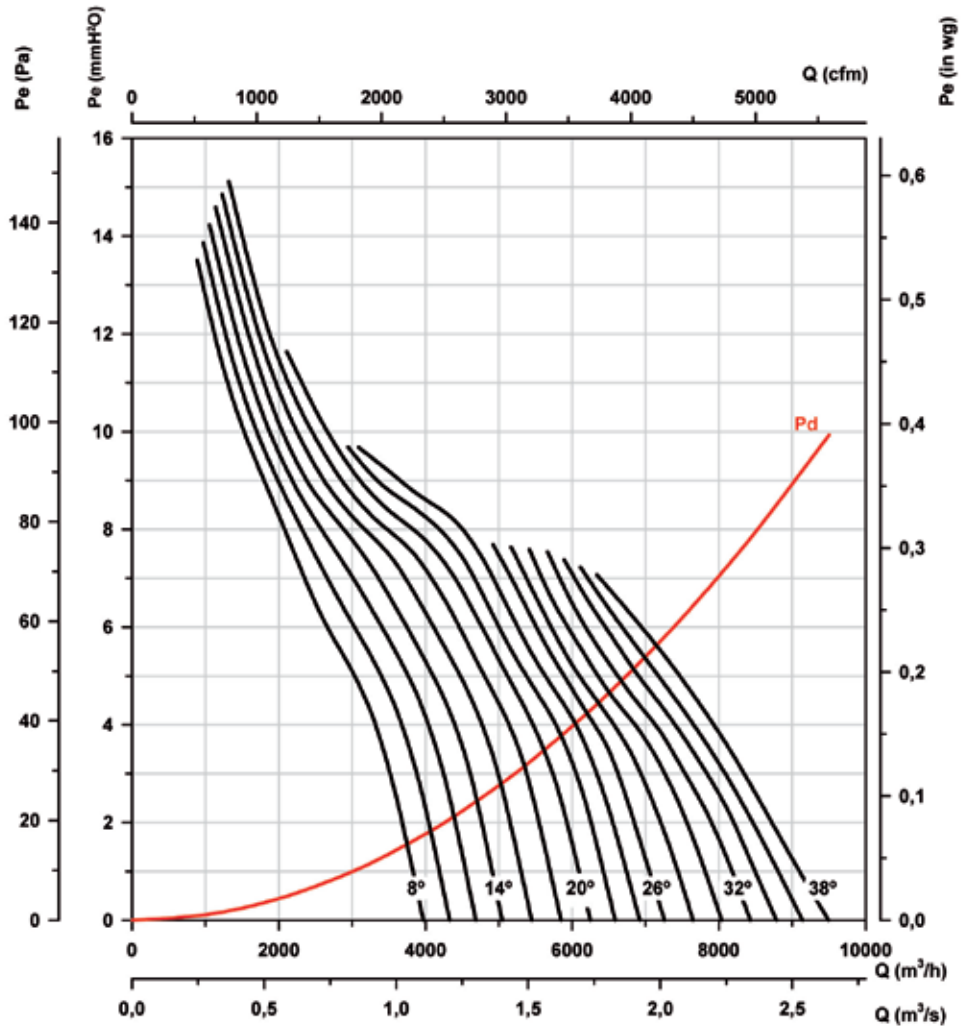

Potencia absorbida

Potencia Motor Recomendada kw(CV)

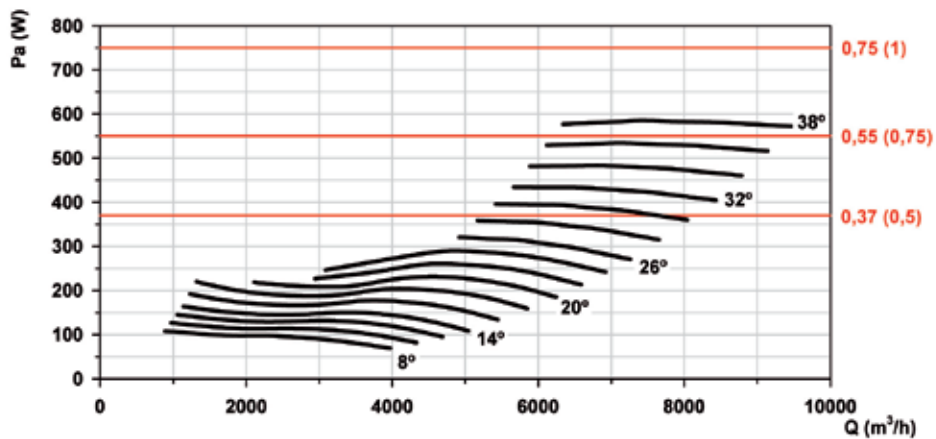

Curvas características

Q= Caudal en m³/h, m³/s y cfm.

Pe= Presión estática en mmH²O, Pa e inwg.

Diámetro Hélice (cm): 56

Número de polos: 2

Número de palas: 6

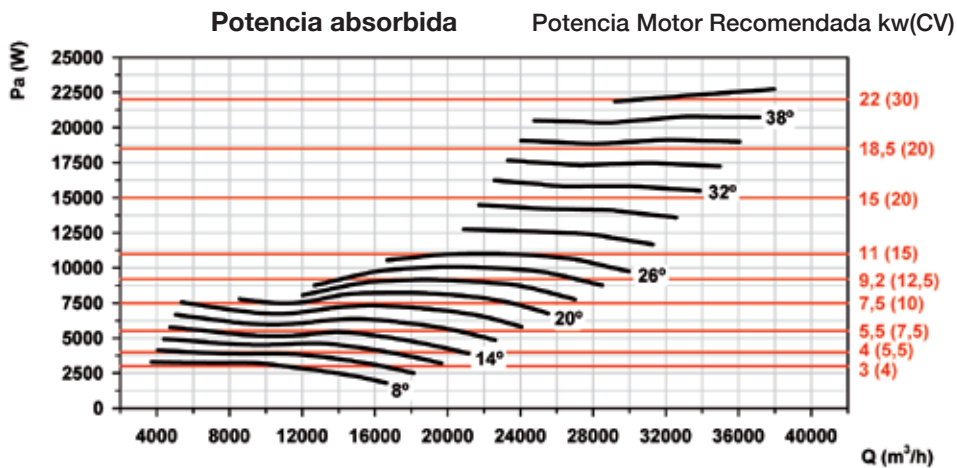
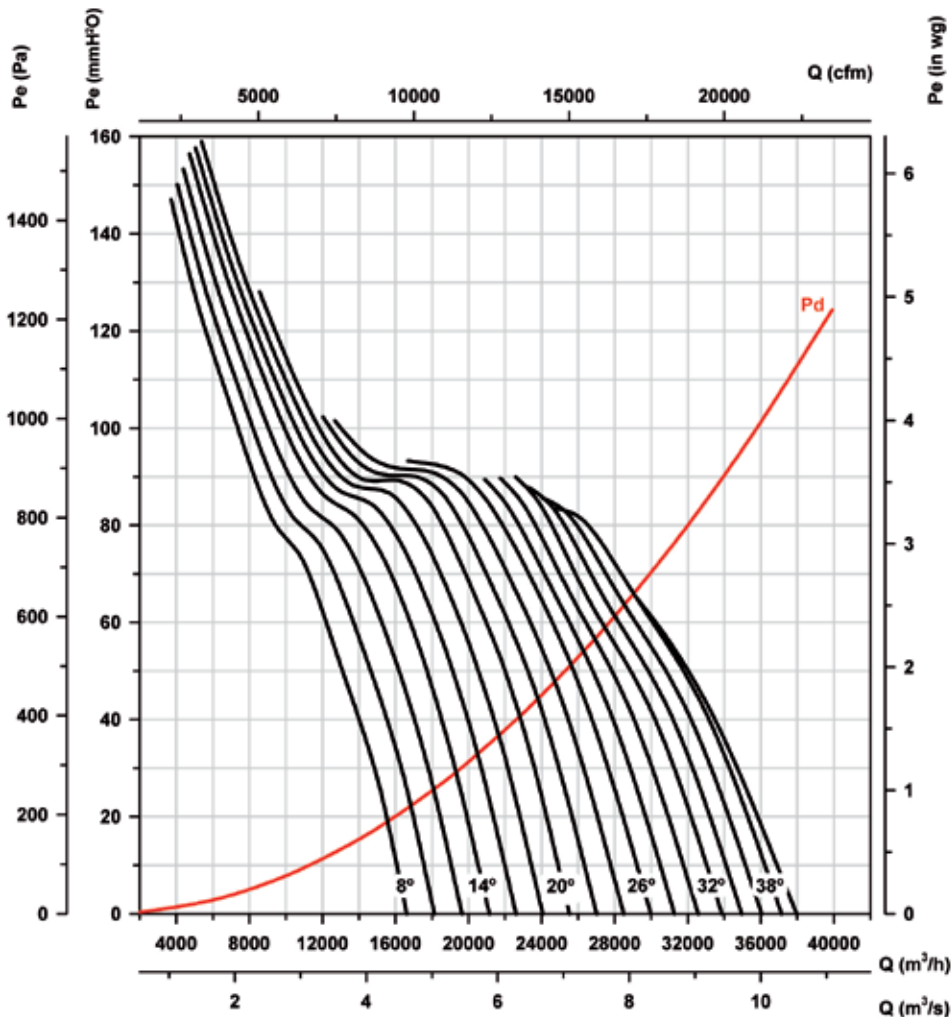

Curvas características

Q= Caudal en m³/h, m³/s y cfm.

Pe= Presión estática en mmH₂O, Pa e inwg.

Diámetro Hélice (cm): 56

Número de polos: 4

Número de palas: 6

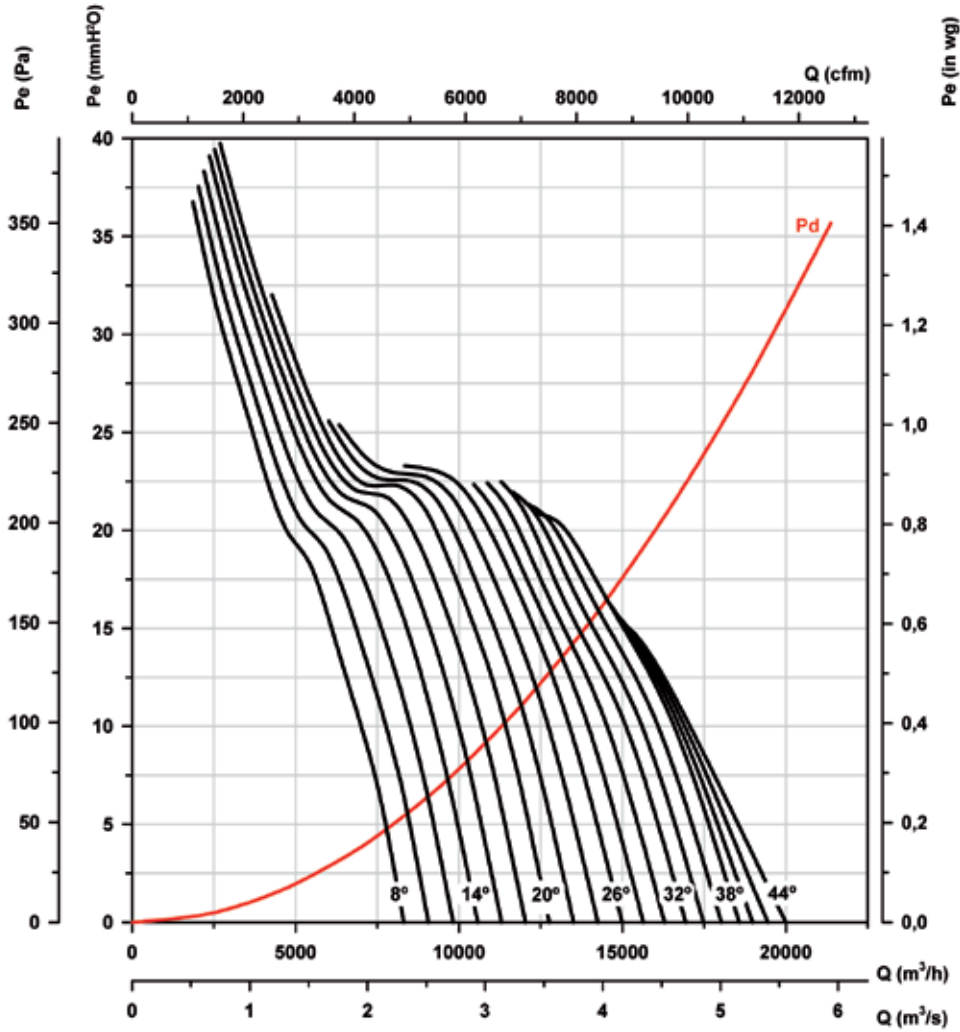

Potencia absorbida

Potencia Motor Recomendada kw(CV)

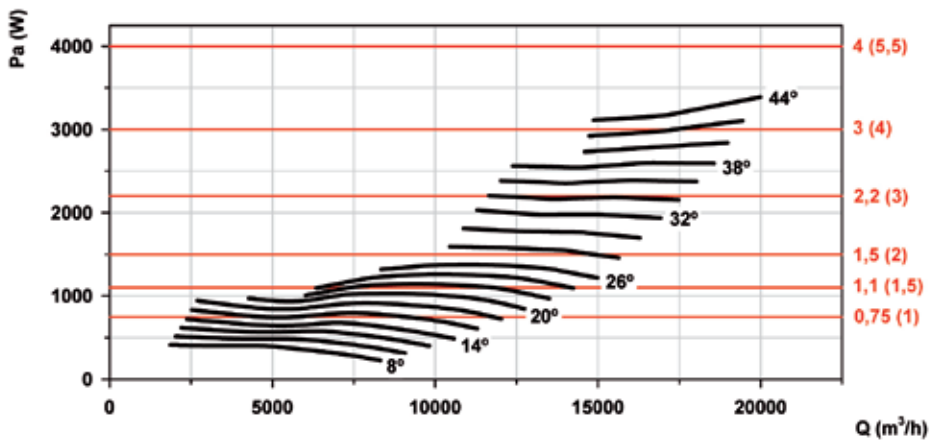

Curvas características

Q= Caudal en m³/h, m³/s y cfm.

Pe= Presión estática en mmH²O, Pa e inwg.

Diámetro Hélice (cm): 56

Número de polos: 6

Número de palas: 6

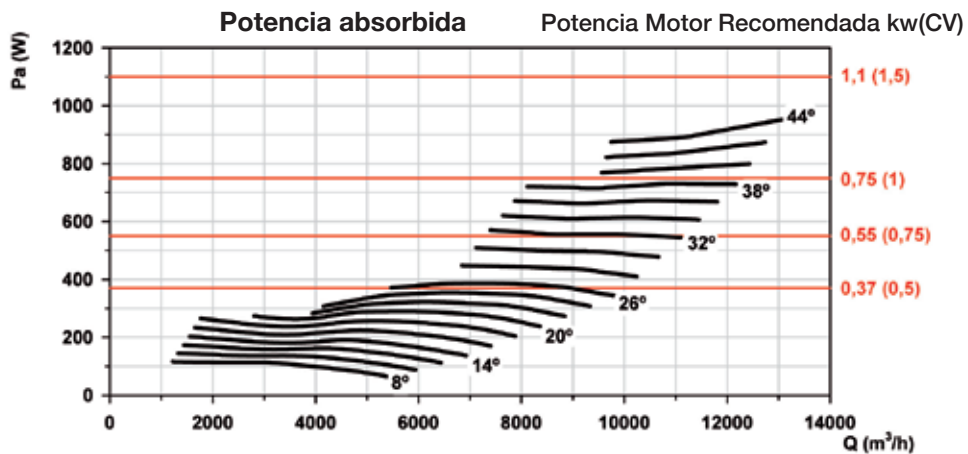
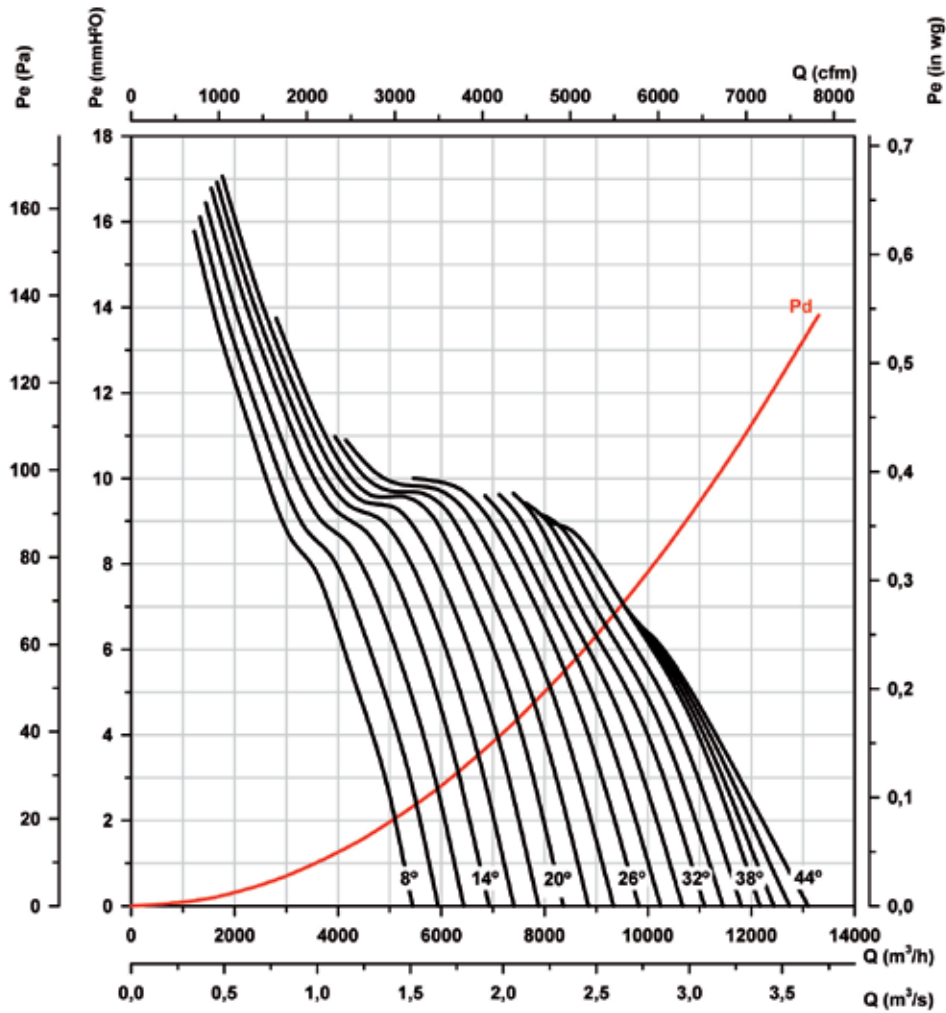

Curvas características

Q= Caudal en m³/h, m³/s y cfm.

Pe= Presión estática en mmH₂O, Pa e inwg.

Diámetro Hélice (cm): 63

Número de polos: 2

Número de palas: 6

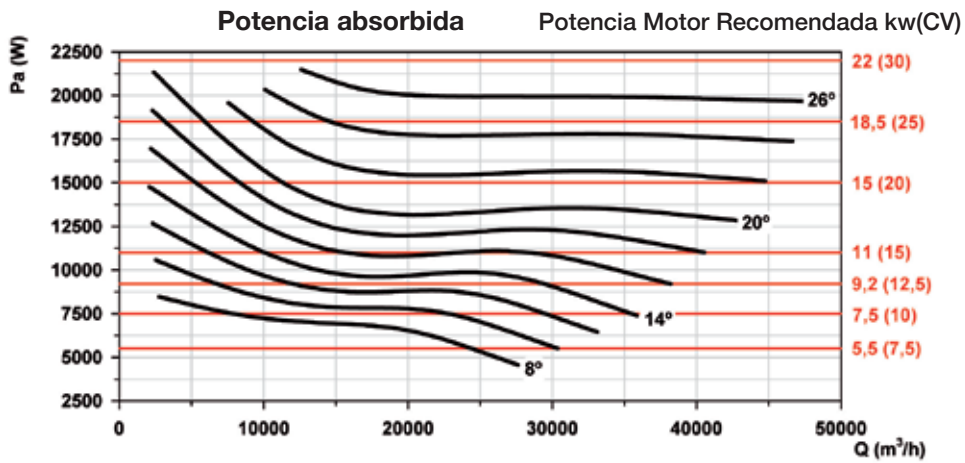
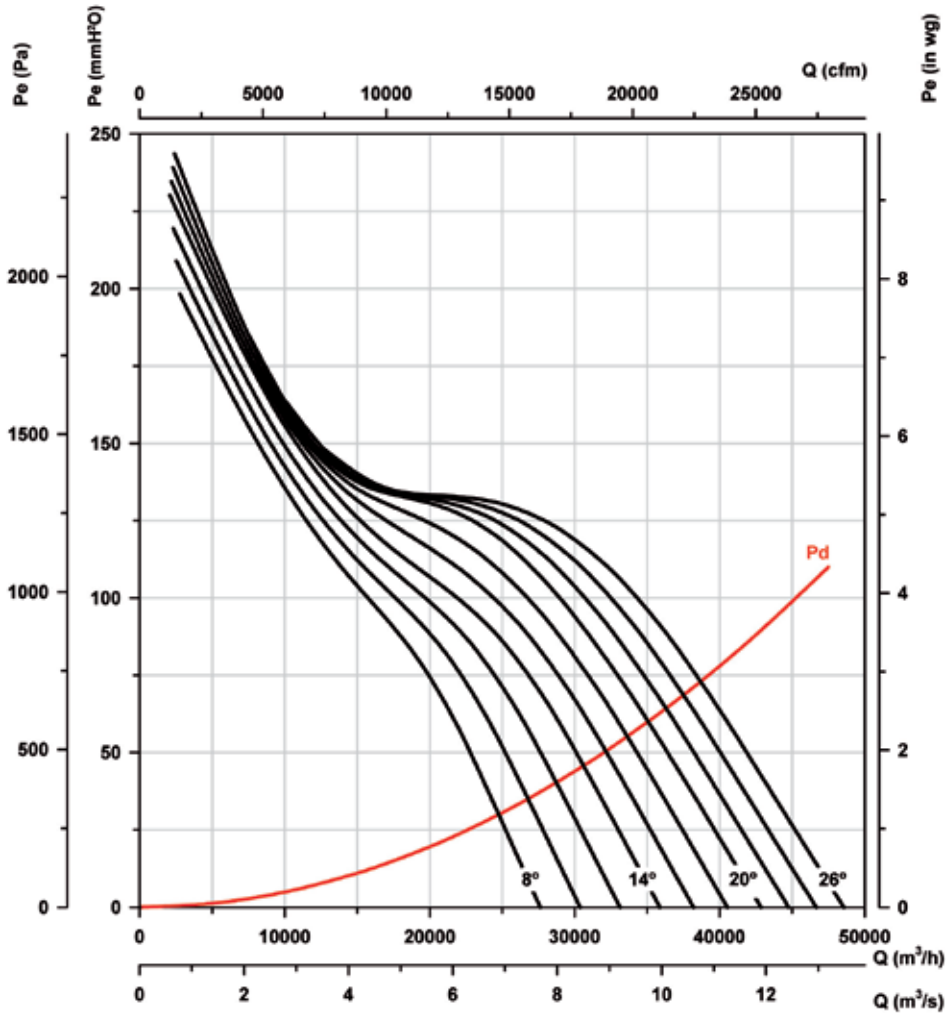

Curvas características

Q= Caudal en m³/h, m³/s y cfm.

Pe= Presión estática en mmH²O, Pa e inwg.

Diámetro Hélice (cm): 63

Número de polos: 4

Número de palas: 6

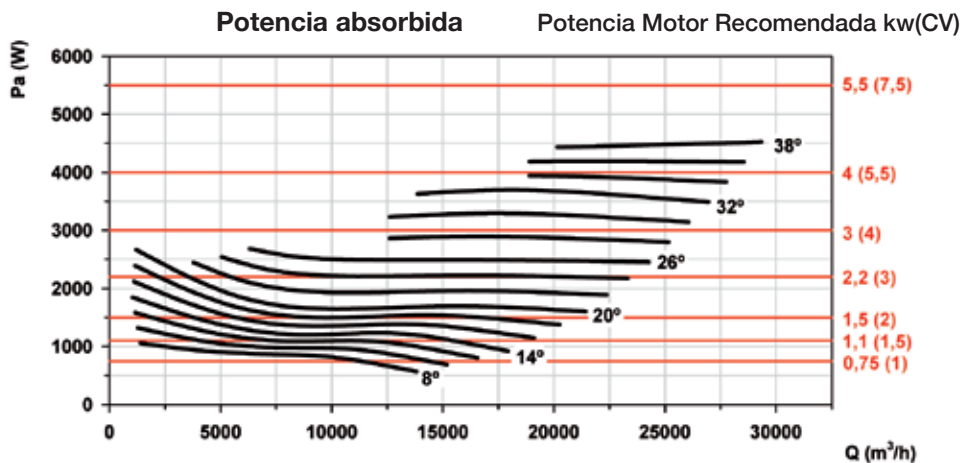
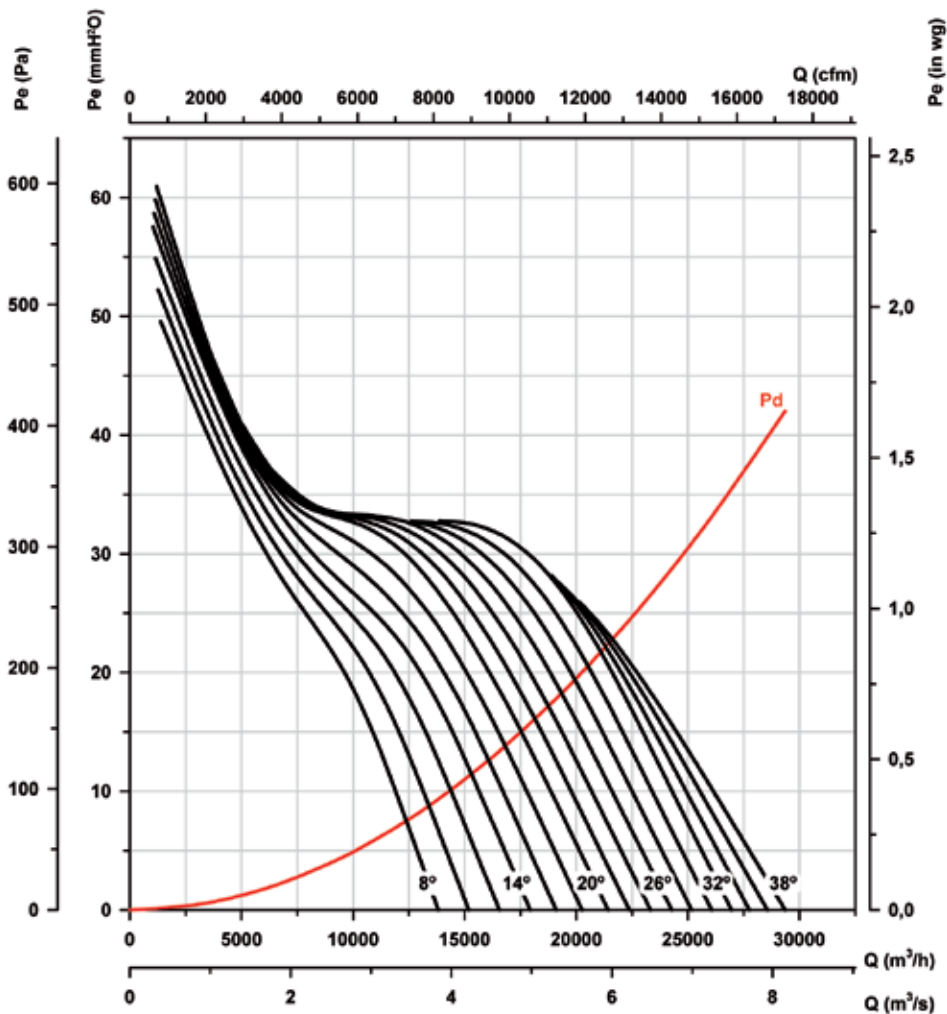

Curvas características

Q= Caudal en m³/h, m³/s y cfm.

Pe= Presión estática en mmH²O, Pa e inwg.

Diámetro Hélice (cm): 63

Número de polos: 6

Número de palas: 6

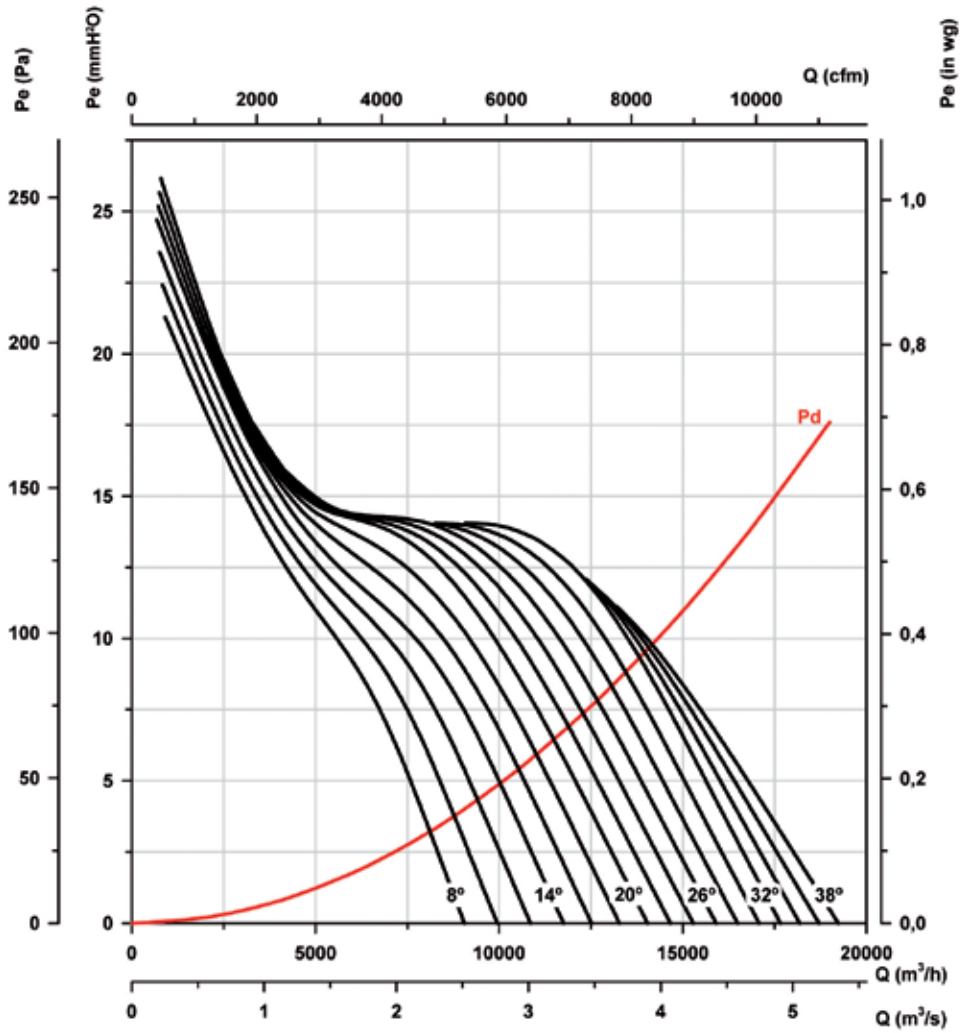

Potencia absorbida

Potencia Motor Recomendada kw(CV)

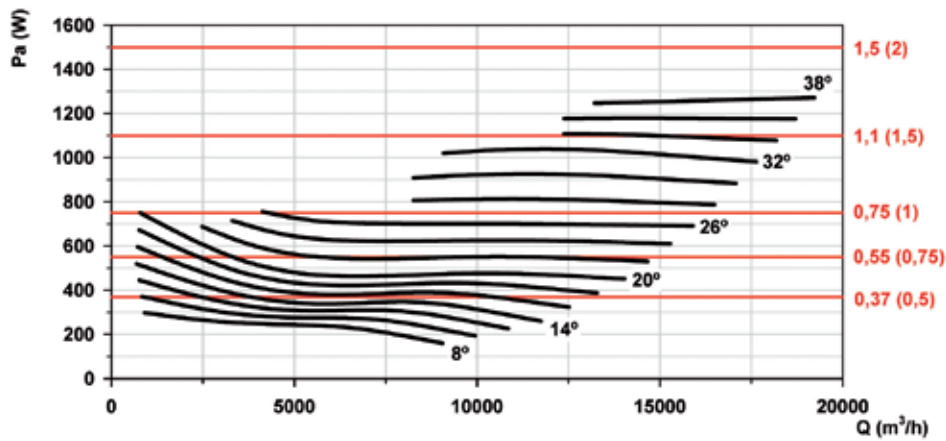

Curvas características

Q= Caudal en m³/h, m³/s y cfm.

Pe= Presión estática en mmH²O, Pa e inwg.

Diámetro Hélice (cm): 71

Número de polos: 4

Número de palas: 6

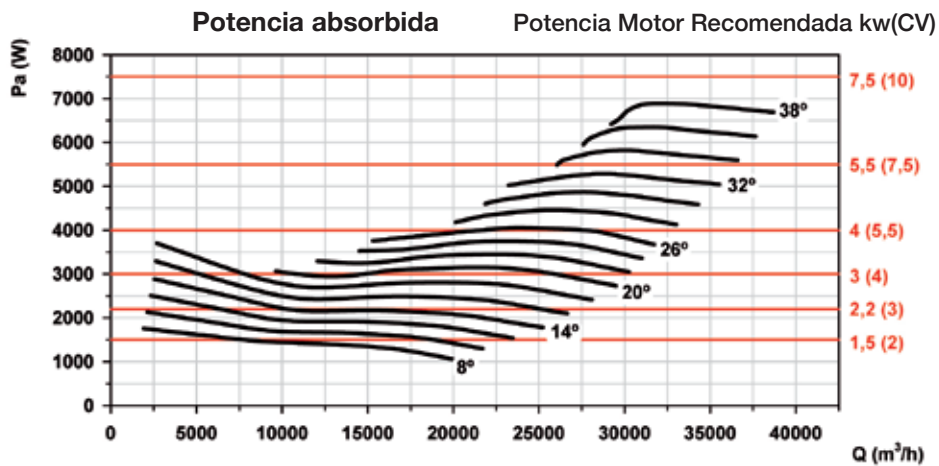
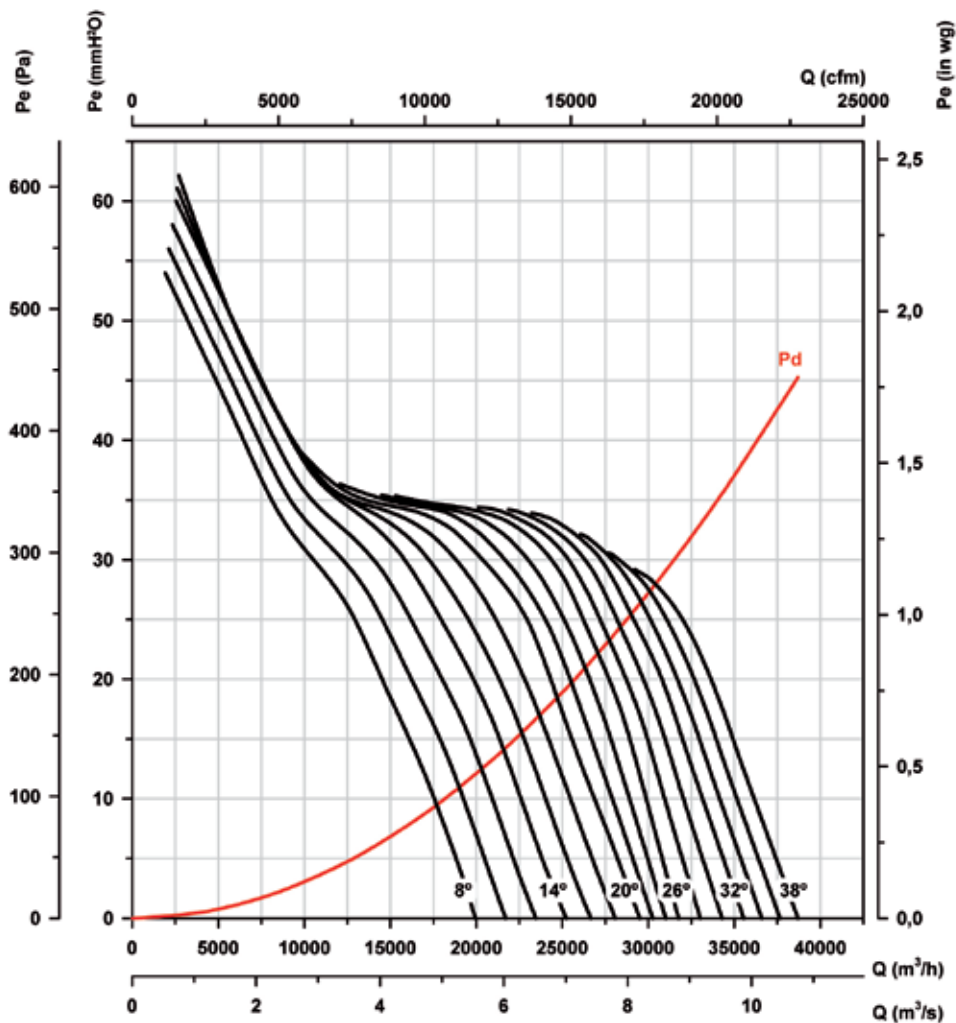

Curvas características

Q= Caudal en m³/h, m³/s y cfm.

Pe= Presión estática en mmH²O, Pa e inwg.

Diámetro Hélice (cm): 71

Número de polos: 6

Número de palas: 6

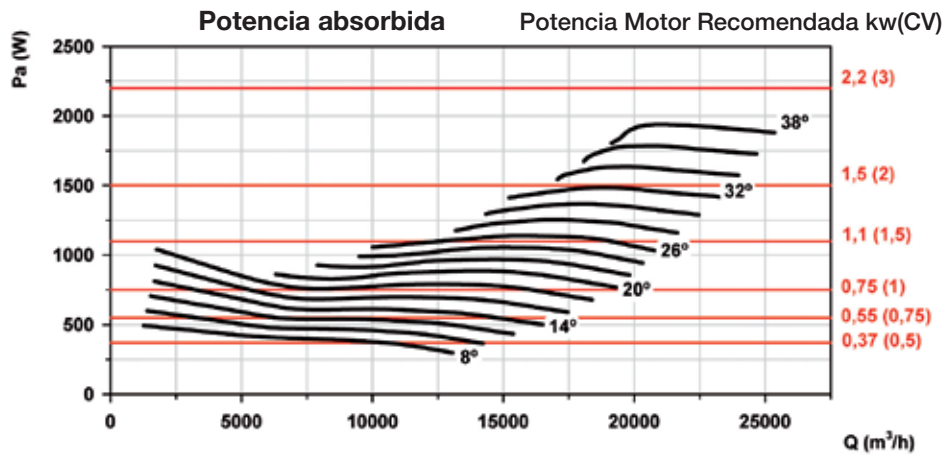
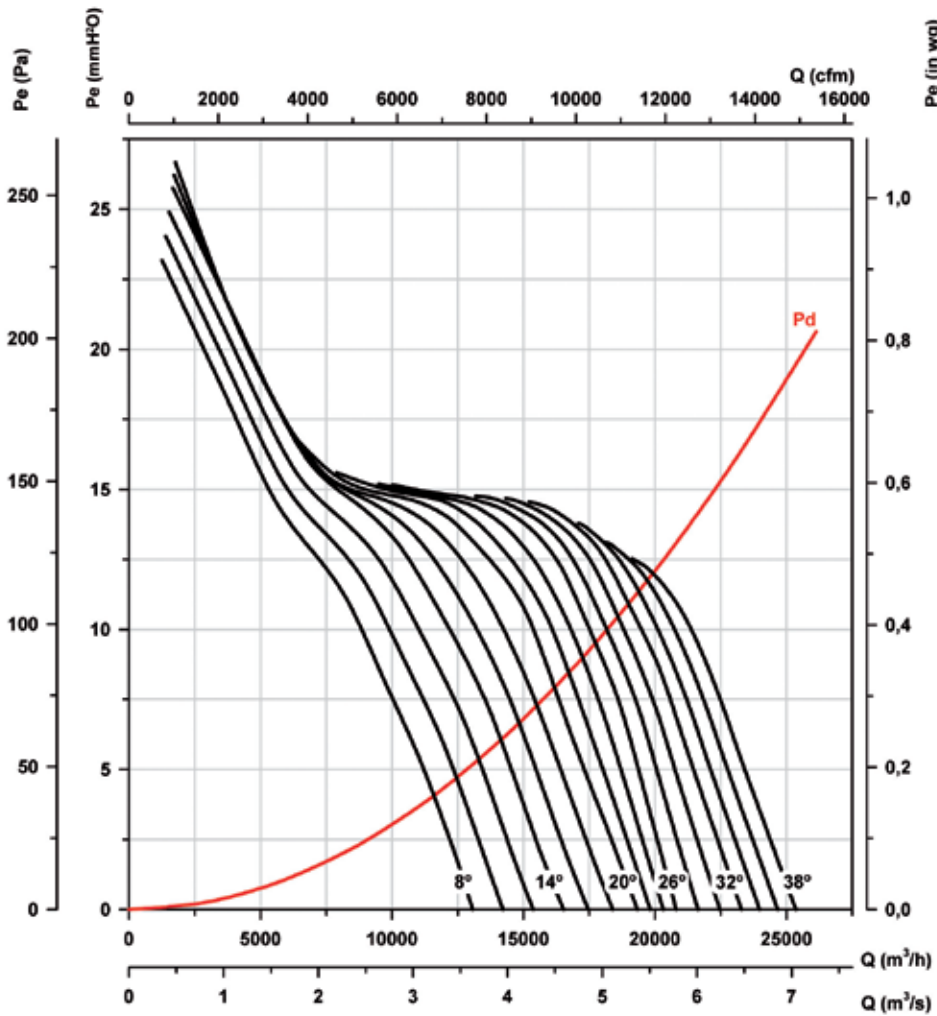

Curvas características

Q= Caudal en m³/h, m³/s y cfm.

Pe= Presión estática en mmH²O, Pa e inwg.

Diámetro Hélice (cm): 80

Número de polos: 4

Número de palas: 6

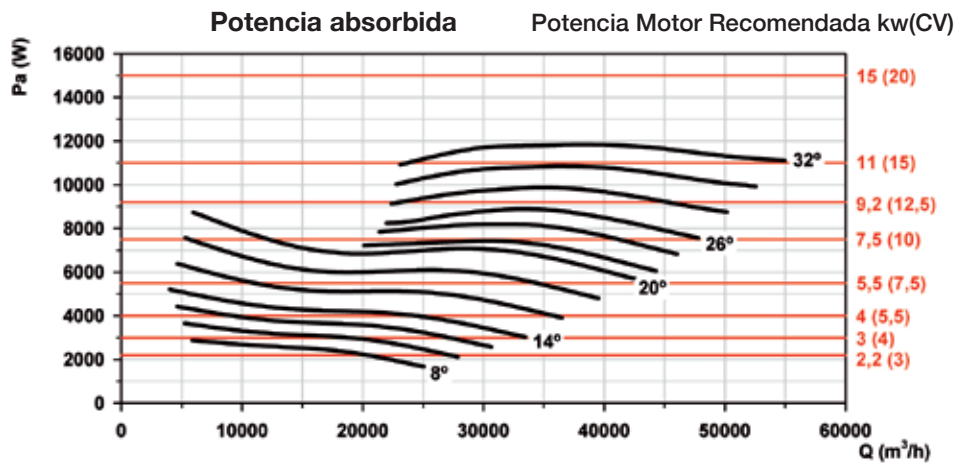
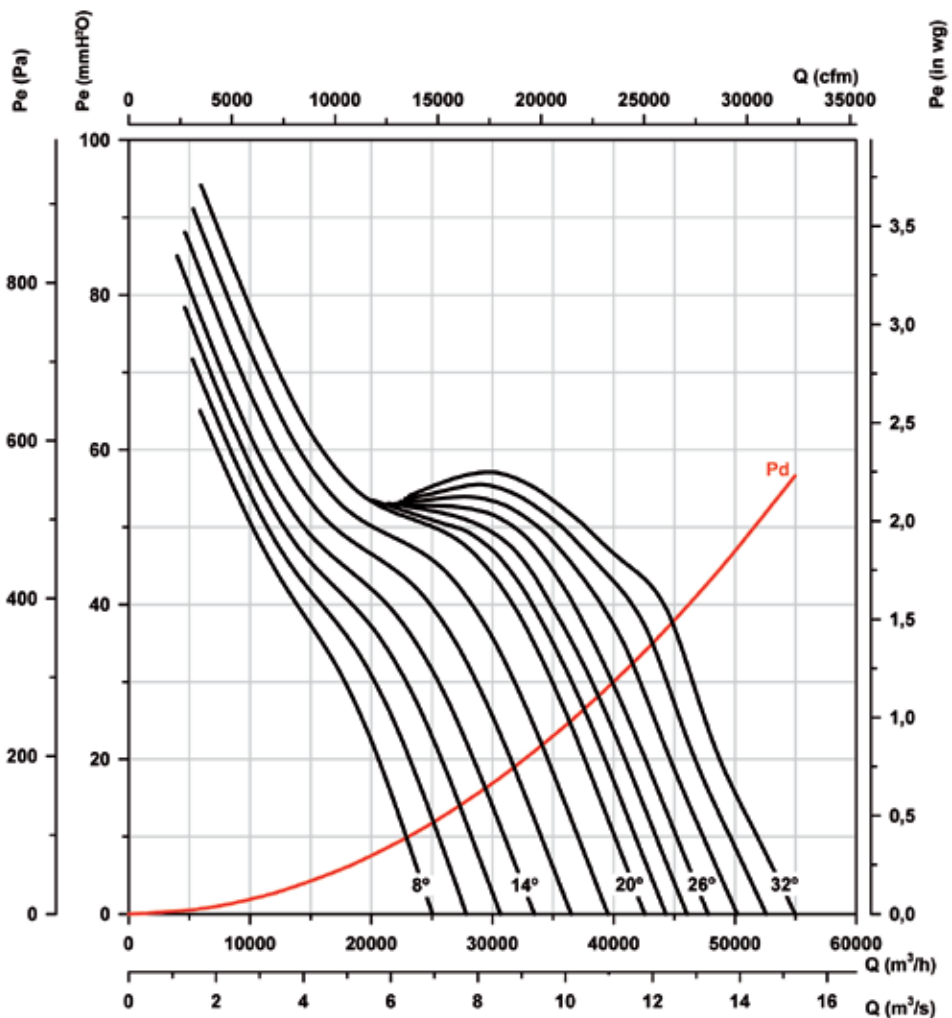

Curvas características

Q= Caudal en m³/h, m³/s y cfm.

Pe= Presión estática en mmH²O, Pa e inwg.

Diámetro Hélice (cm): 80

Número de polos: 6

Número de palas: 6

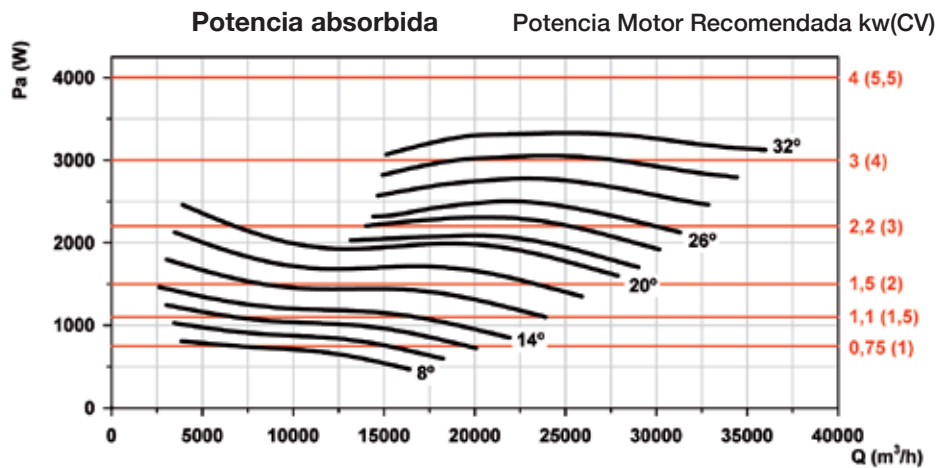
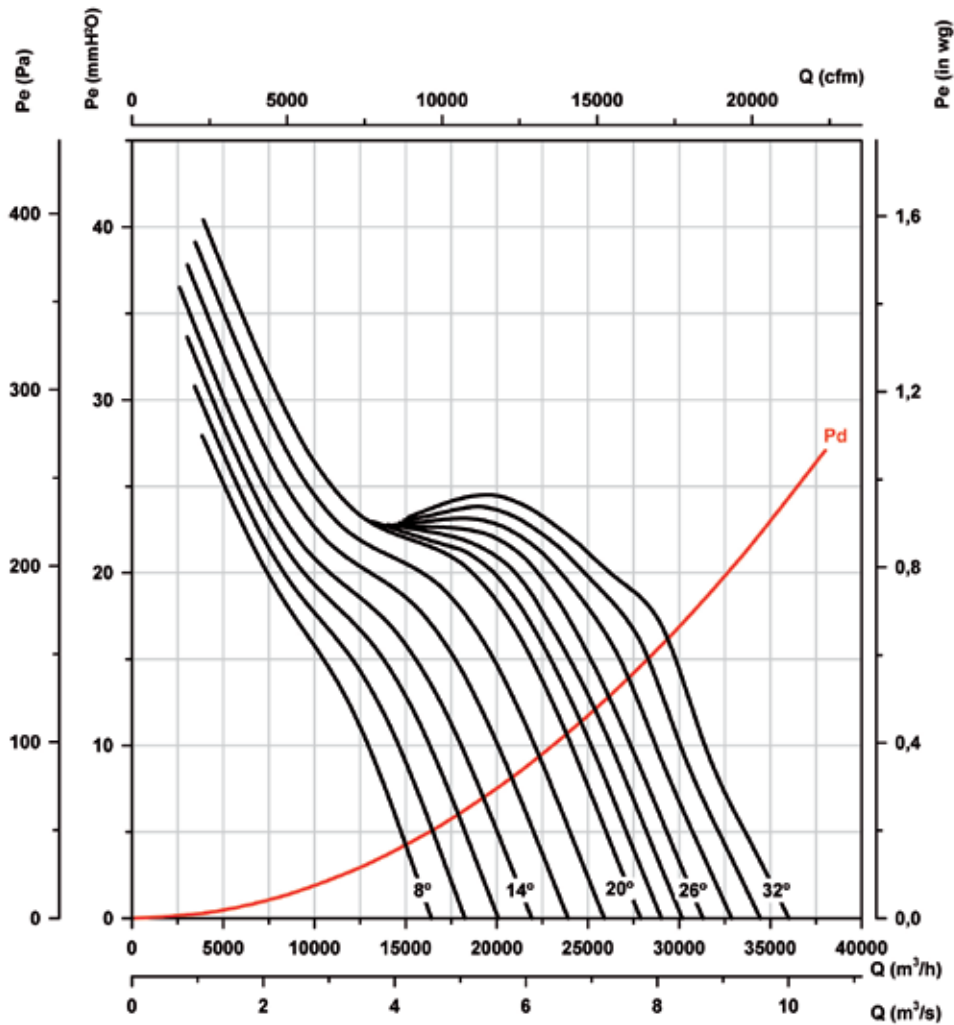

Curvas características

Q= Caudal en m³/h, m³/s y cfm.

Pe= Presión estática en mmH²O, Pa e inwg.

Diámetro Hélice (cm): 80

Número de polos: 8

Número de palas: 6

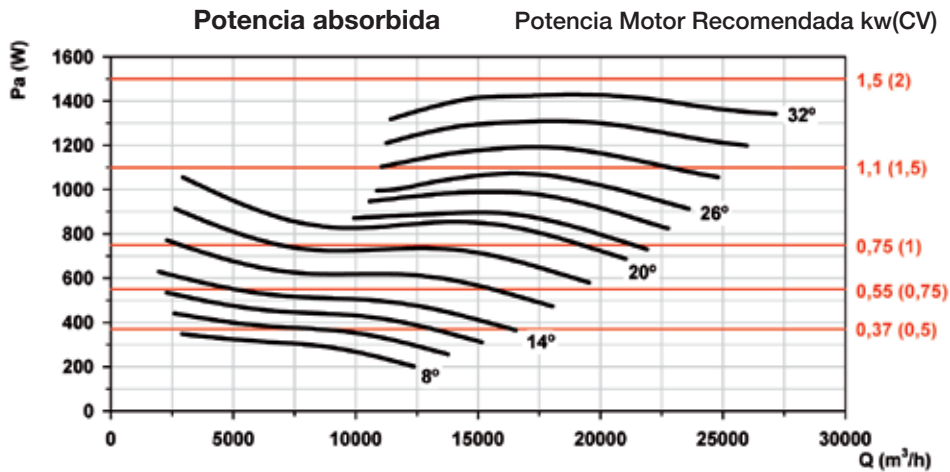
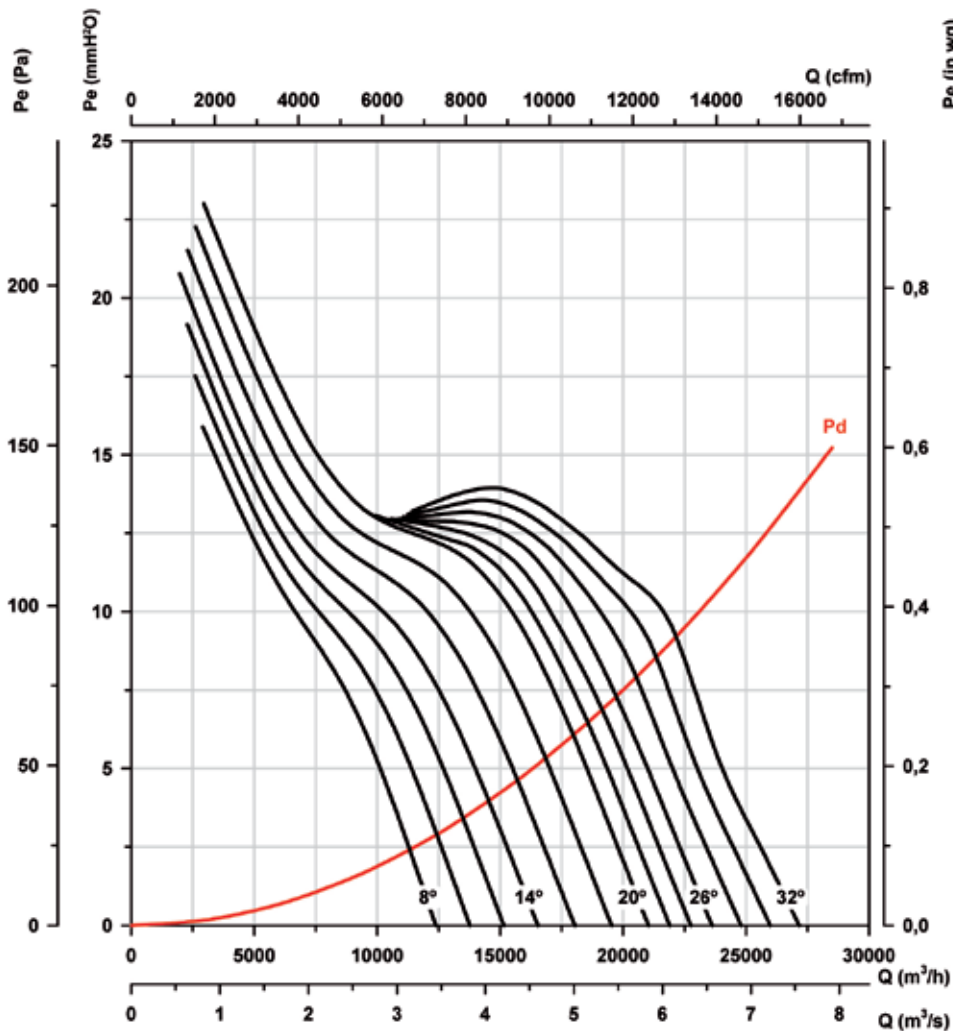

Curvas características

Q= Caudal en m³/h, m³/s y cfm.

Pe= Presión estática en mmH²O, Pa e inwg.

Diámetro Hélice (cm): 90

Número de polos: 4

Número de palas: 6

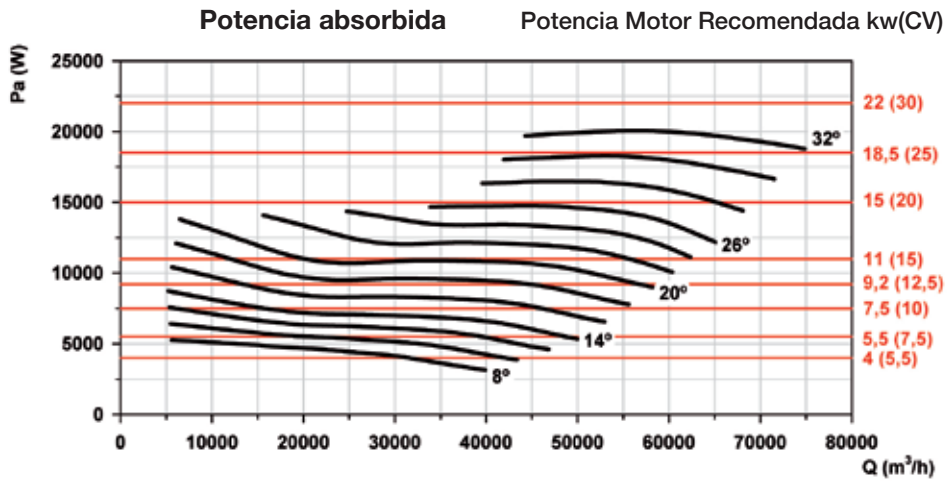
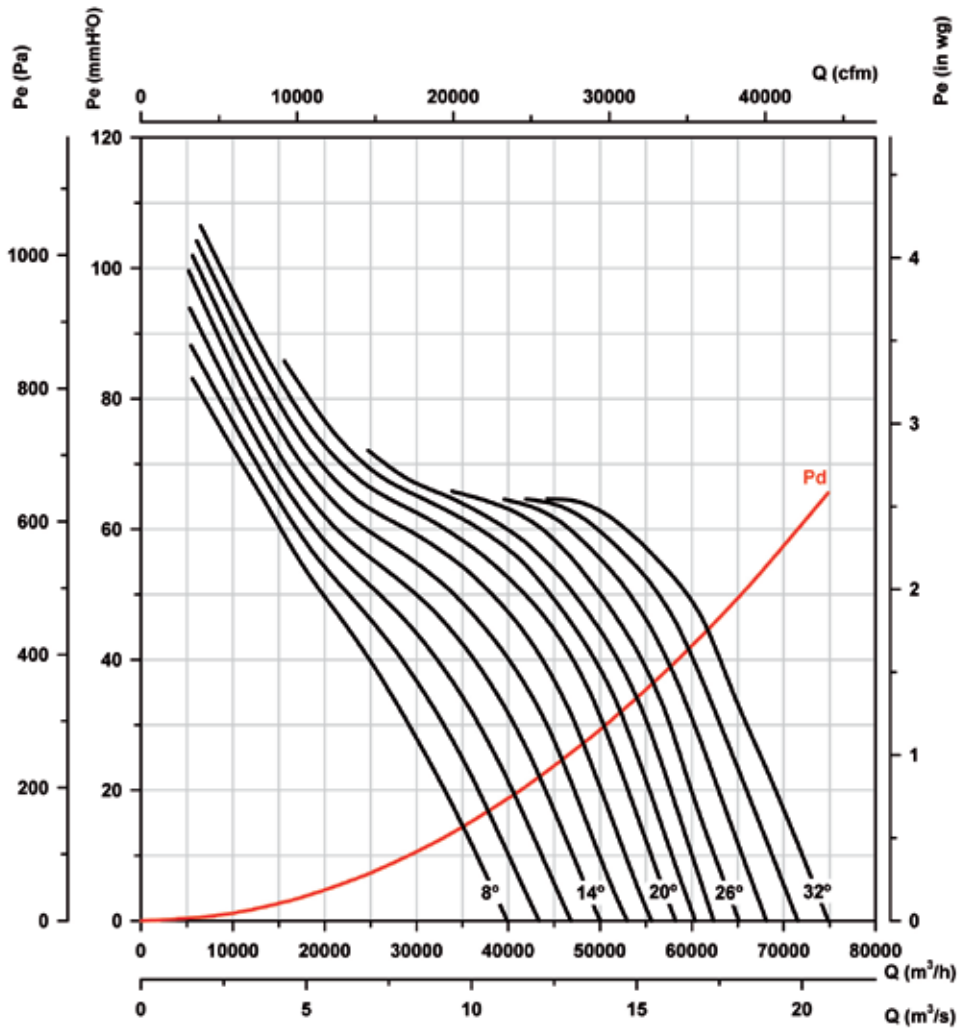

Curvas características

Q= Caudal en m³/h, m³/s y cfm.

Pe= Presión estática en mmH₂O, Pa e inwg.

Diámetro Hélice (cm): 90

Número de polos: 6

Número de palas: 6

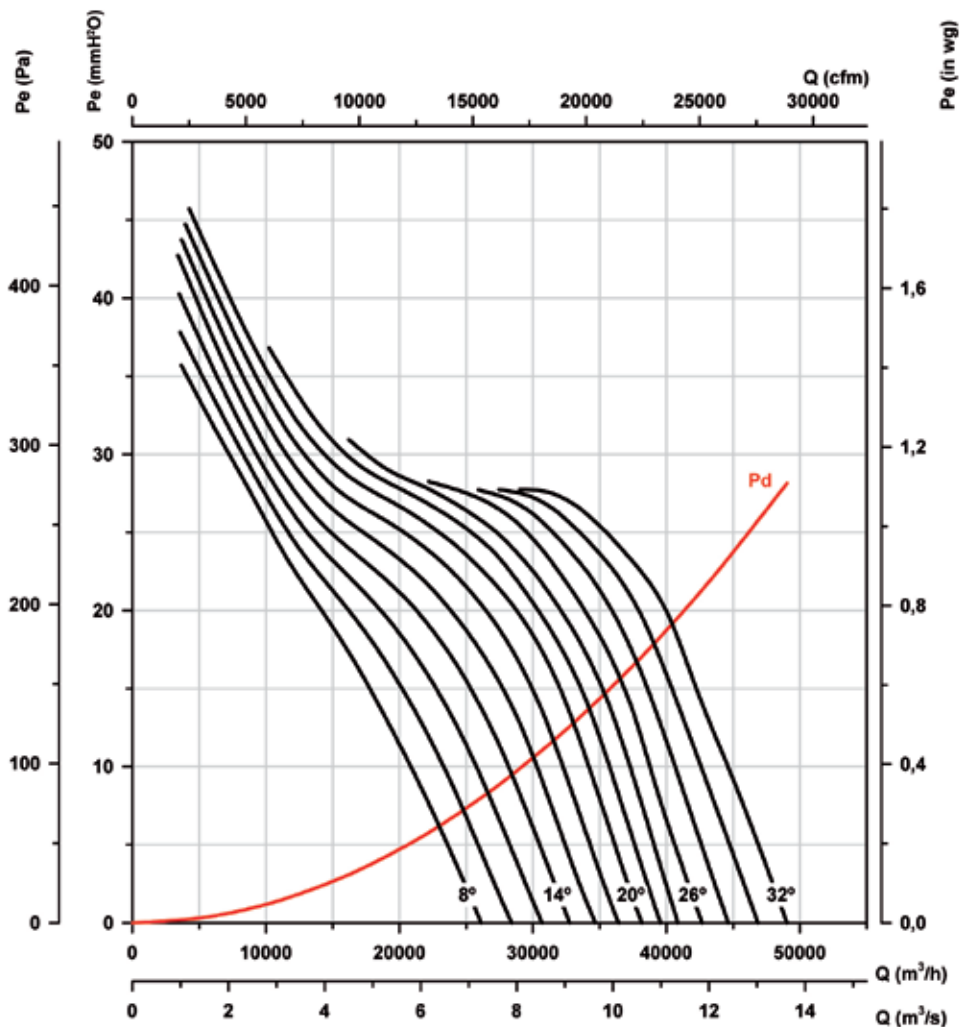

Potencia absorbida

Potencia Motor Recomendada kw(CV)

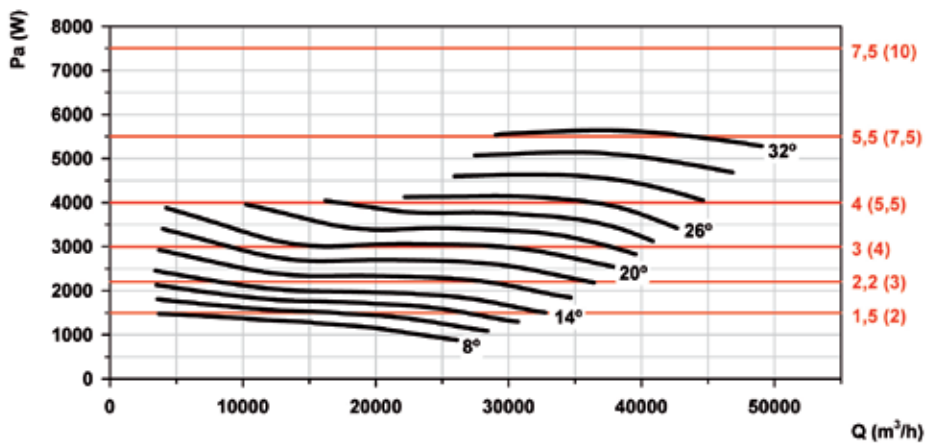

Curvas características

Q= Caudal en m³/h, m³/s y cfm.

Pe= Presión estática en mmH²O, Pa e inwg.

Diámetro Hélice (cm): 90

Número de polos: 8

Número de palas: 6

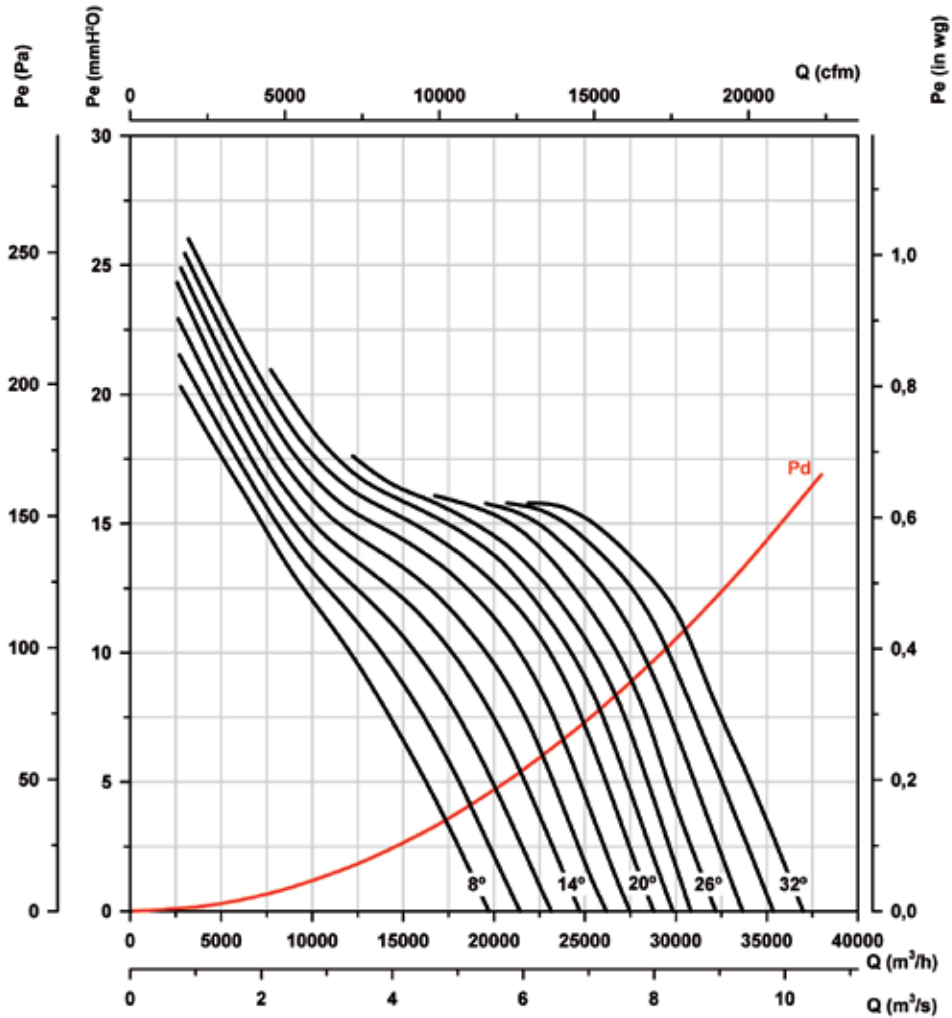

Potencia absorbida

Potencia Motor Recomendada kw(CV)

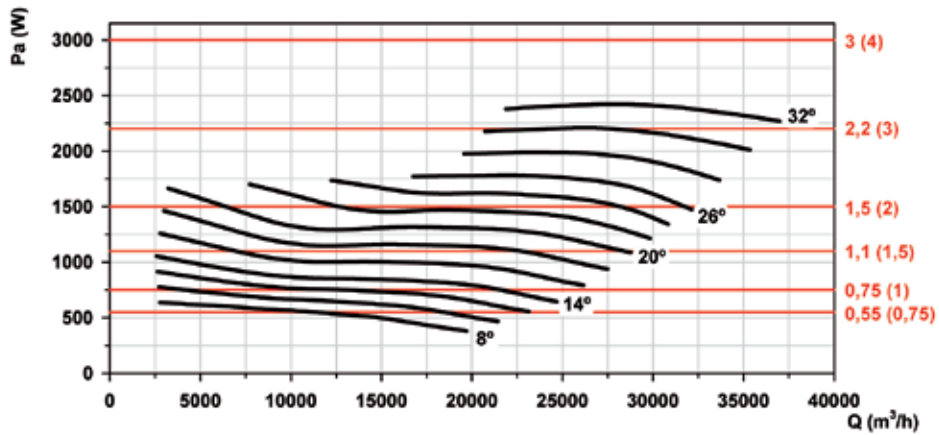

Curvas características

Q= Caudal en m³/h, m³/s y cfm. Pe= Presión estática en mmH₂O, Pa e inwg.

Diámetro Hélice (cm): 100

Número de polos: 4

Número de palas: 6

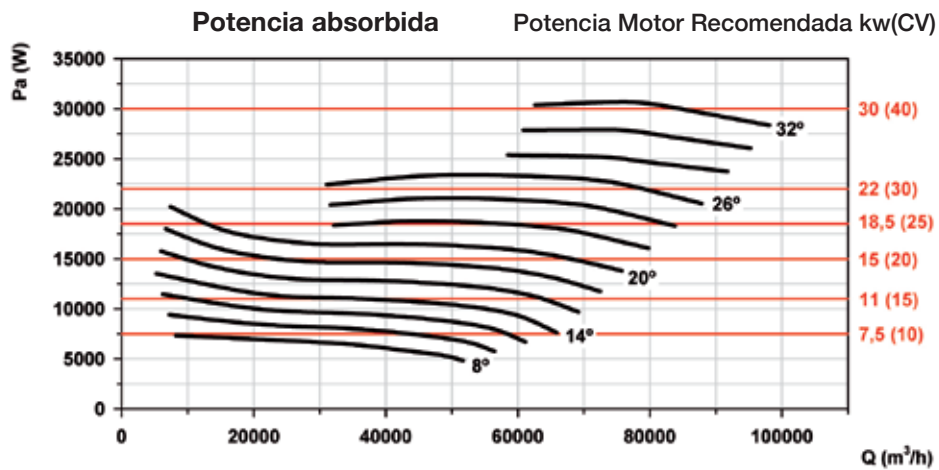
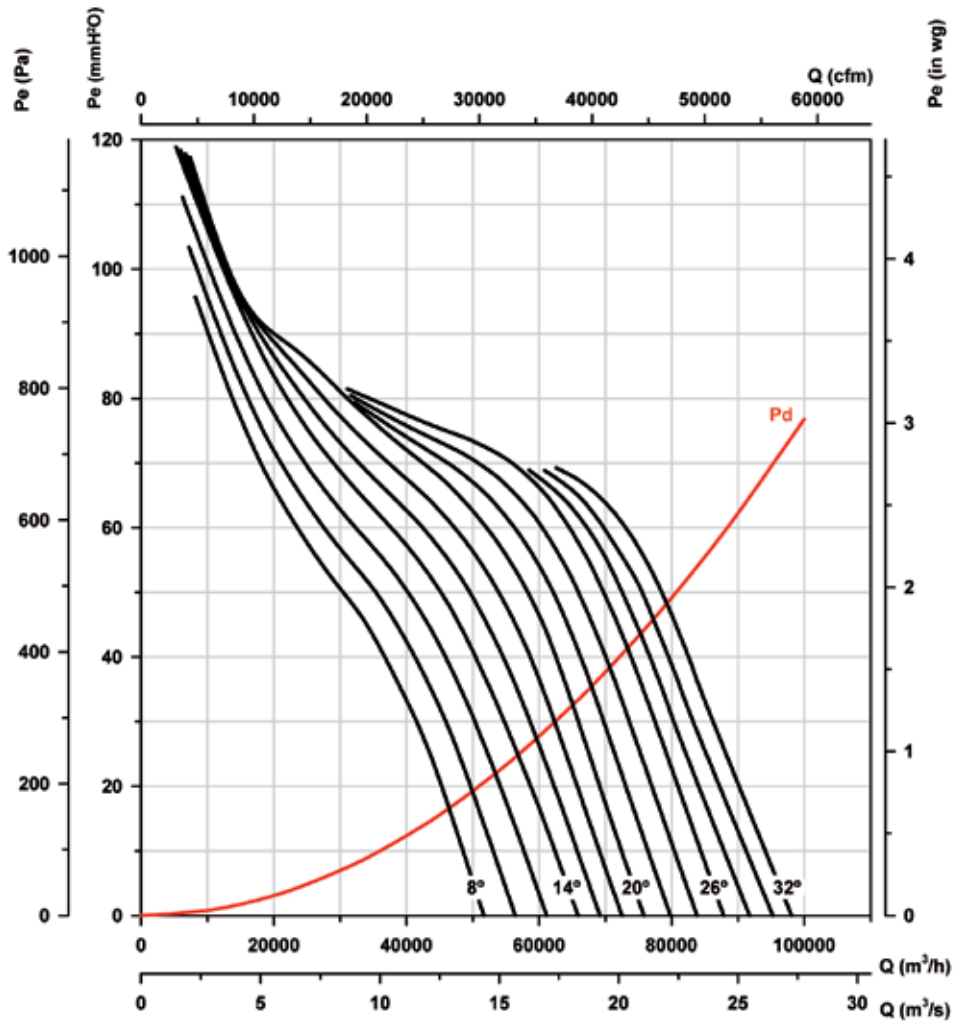

Curvas características

Q= Caudal en m³/h, m³/s y cfm.

Pe= Presión estática en mmH₂O, Pa e inwg.

Diámetro Hélice (cm): 100 Número de polos: 6

Número de palas: 6

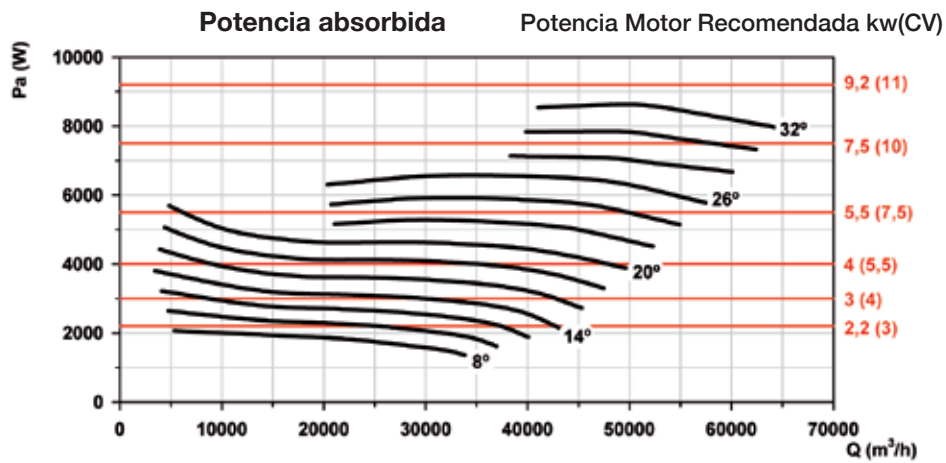
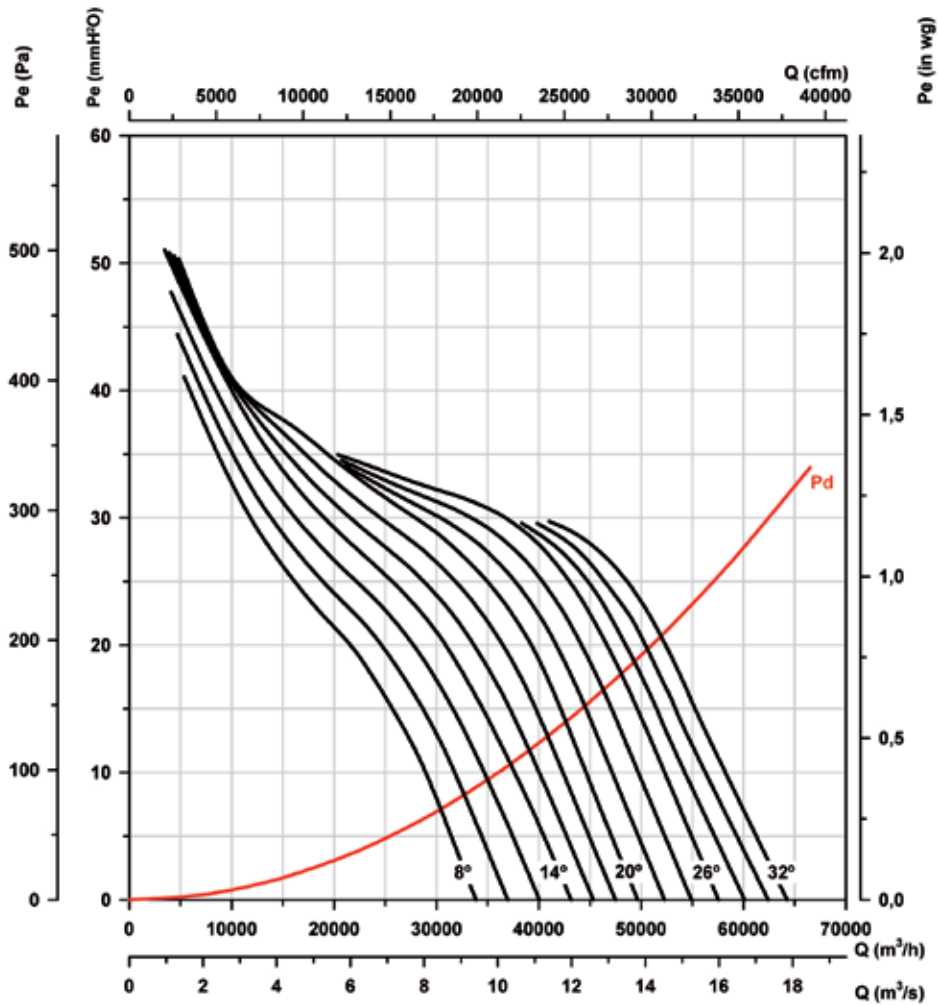

Curvas características

Q= Caudal en m³/h, m³/s y cfm.

Pe= Presión estática en mmH²O, Pa e inwg.

Diámetro Hélice (cm): 100

Número de polos: 8

Número de palas: 6

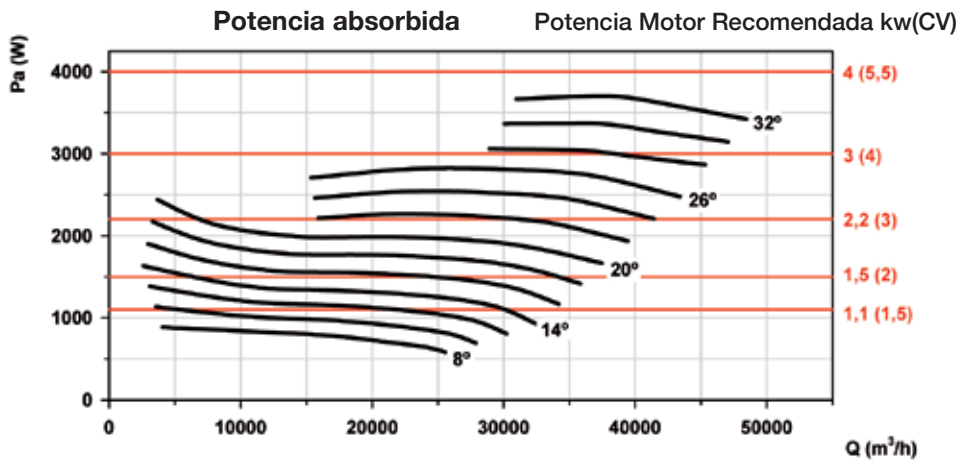
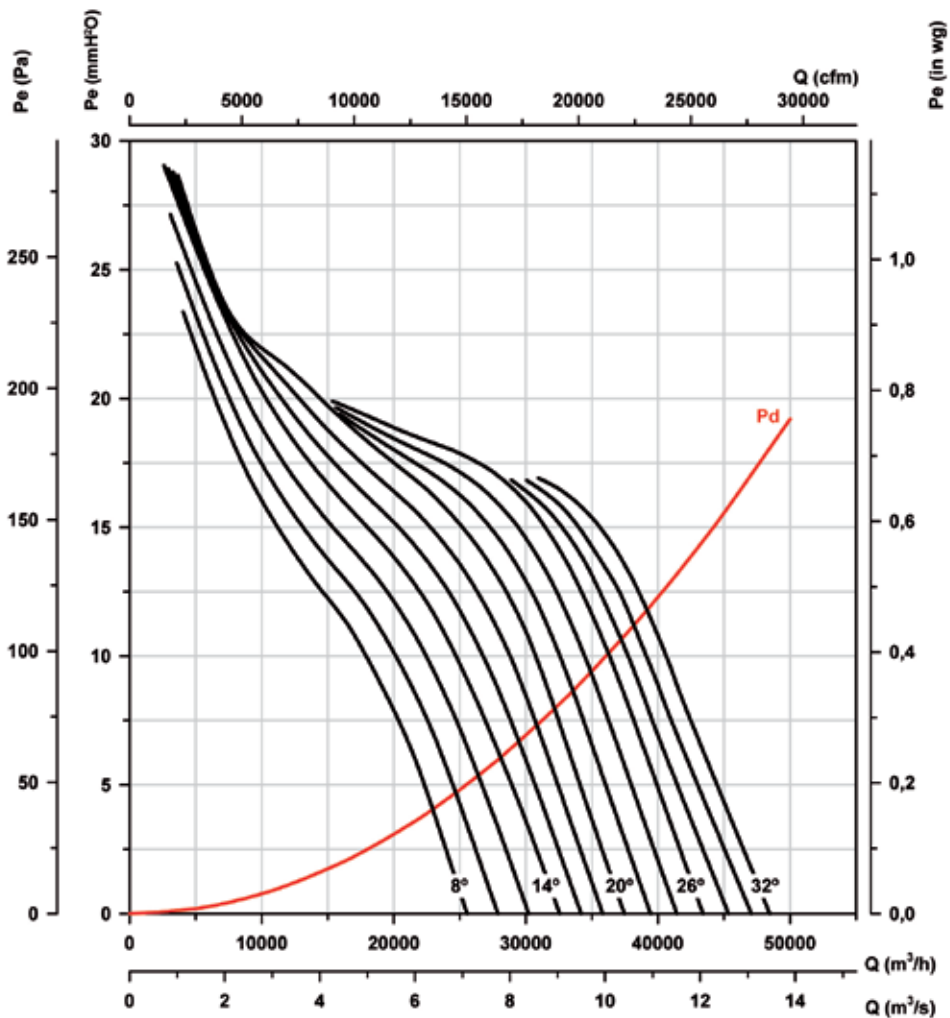

Curvas características

Q= Caudal en m³/h, m³/s y cfm.

Pe= Presión estática en mmH₂O, Pa e inwg.

Diámetro Hélice (cm): 125

Número de polos: 4

Número de palas: 3

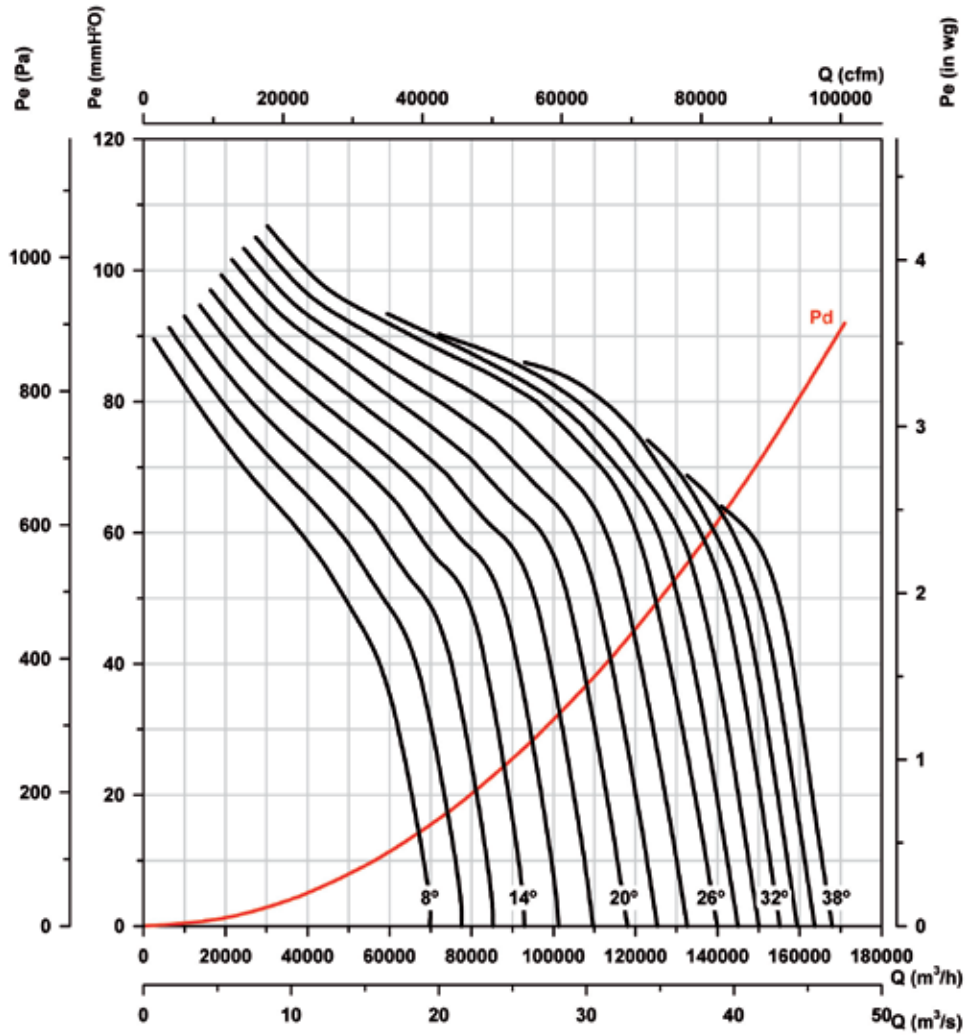

Potencia absorbida

Potencia Motor Recomendada kw(CV)

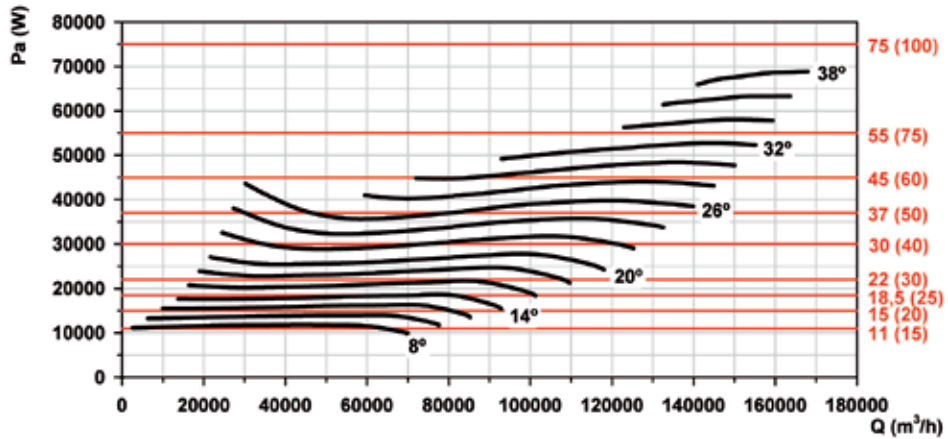

Curvas características

Q= Caudal en m³/h, m³/s y cfm.

Pe= Presión estática en mmH²O, Pa e inwg.

Diámetro Hélice (cm): 125

Número de polos: 4

Número de palas: 6

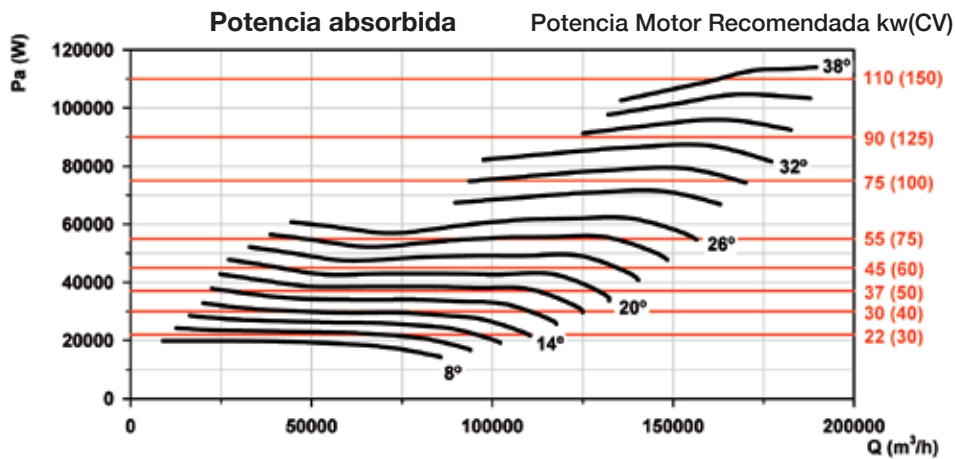
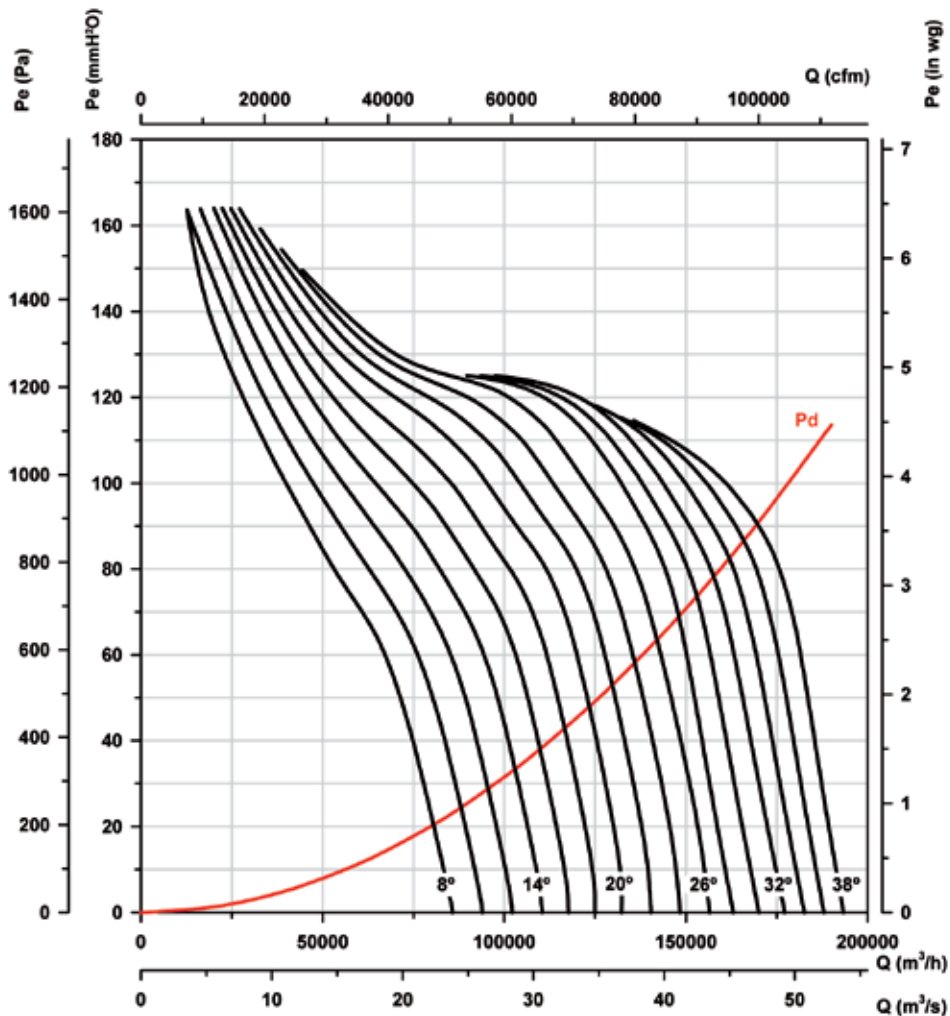

Curvas características

Q= Caudal en m³/h, m³/s y cfm.

Pe= Presión estática en mmH²O, Pa e inwg.

Diámetro Hélice (cm): 125

Número de polos: 4

Número de palas: 9

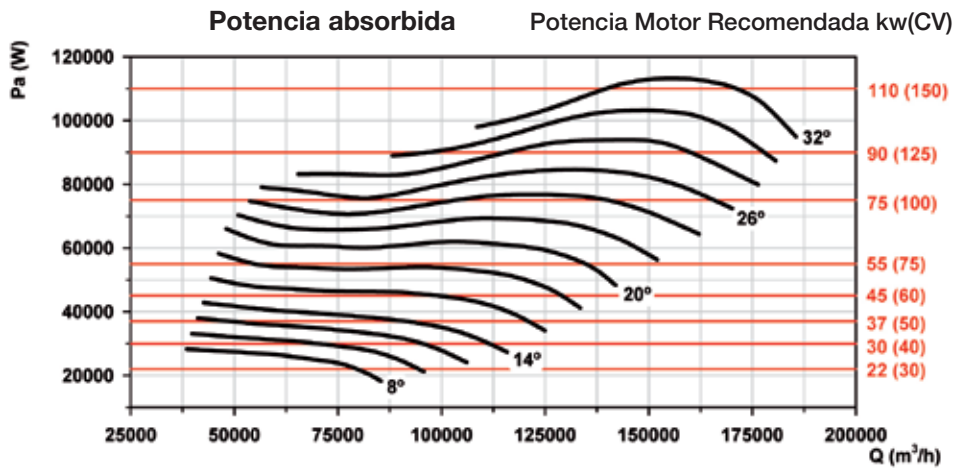
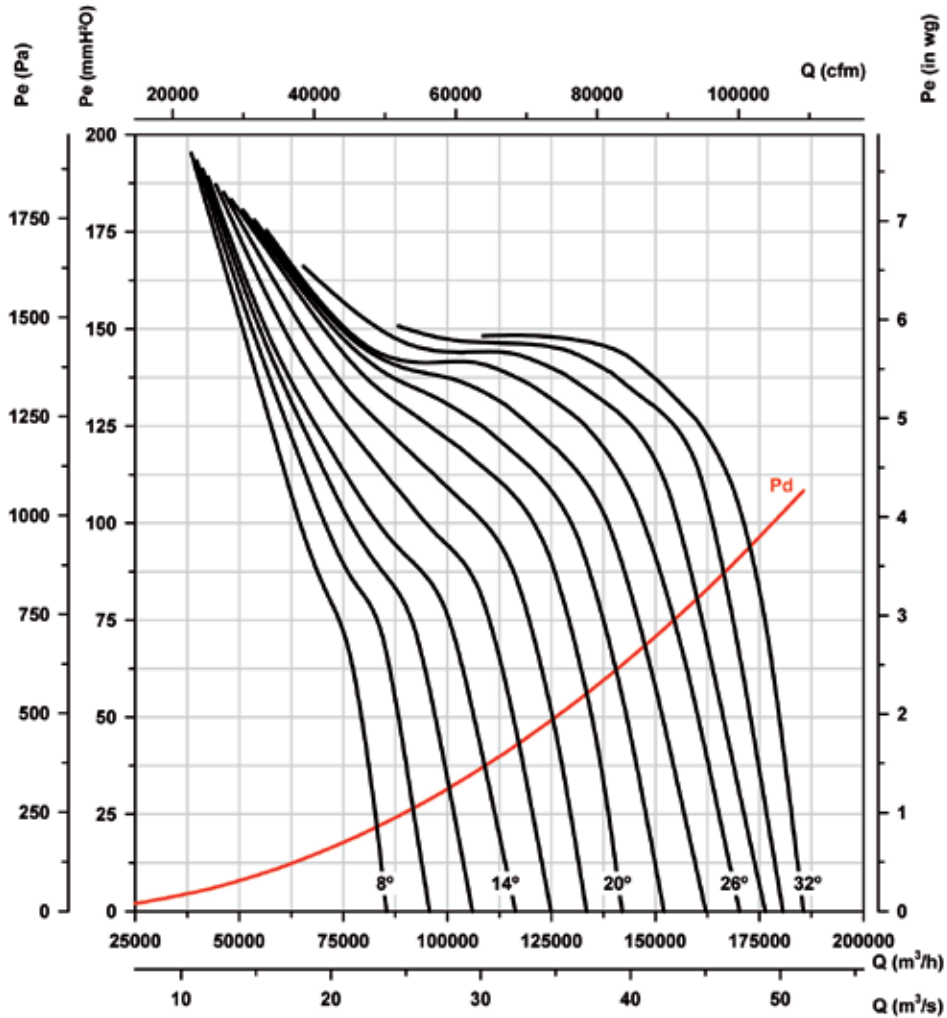

Curvas características

Q= Caudal en m³/h, m³/s y cfm. Pe= Presión estática en mmH²O, Pa e inwg.

Diámetro Hélice (cm): 125

Número de polos: 6

Número de palas: 3

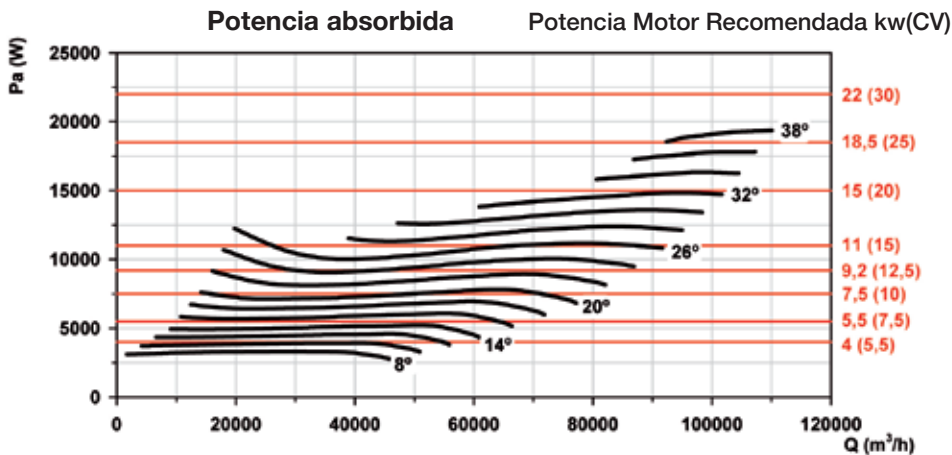
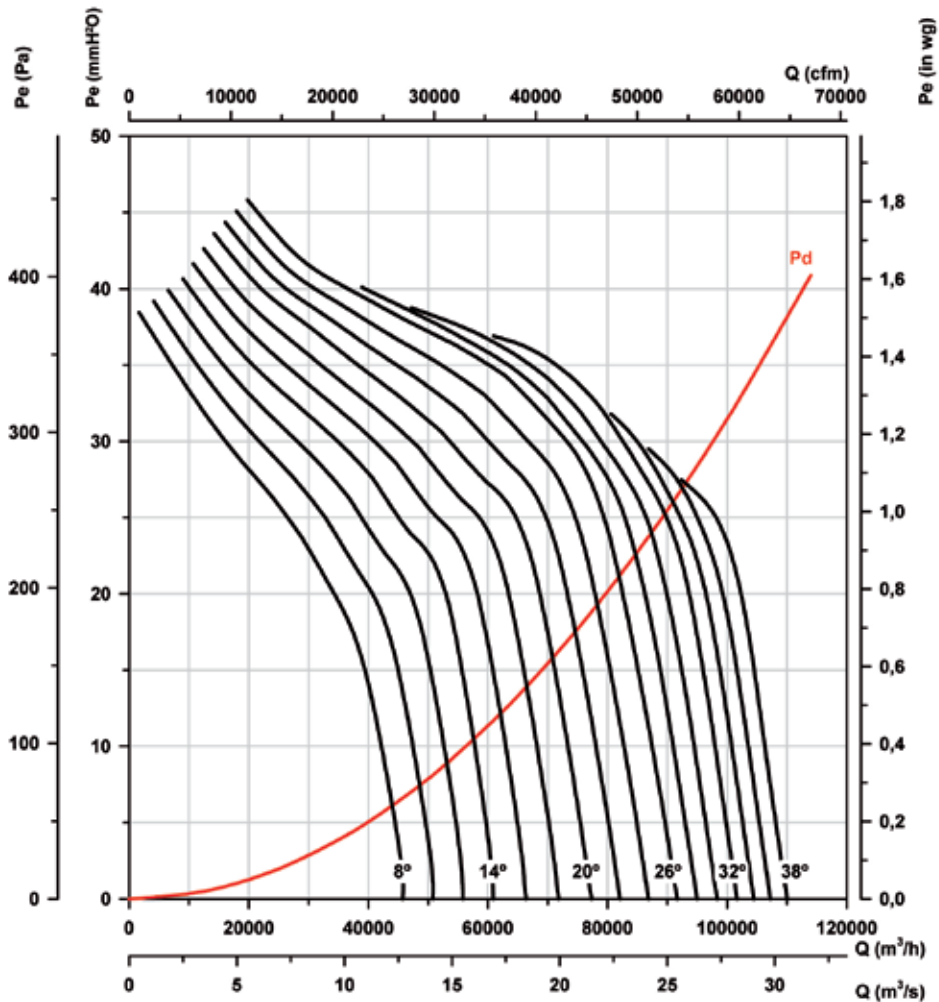

Curvas características

Q= Caudal en m³/h, m³/s y cfm.

Pe= Presión estática en mmH₂O, Pa e inwg.

Diámetro Hélice (cm): 125

Número de polos: 6

Número de palas: 6

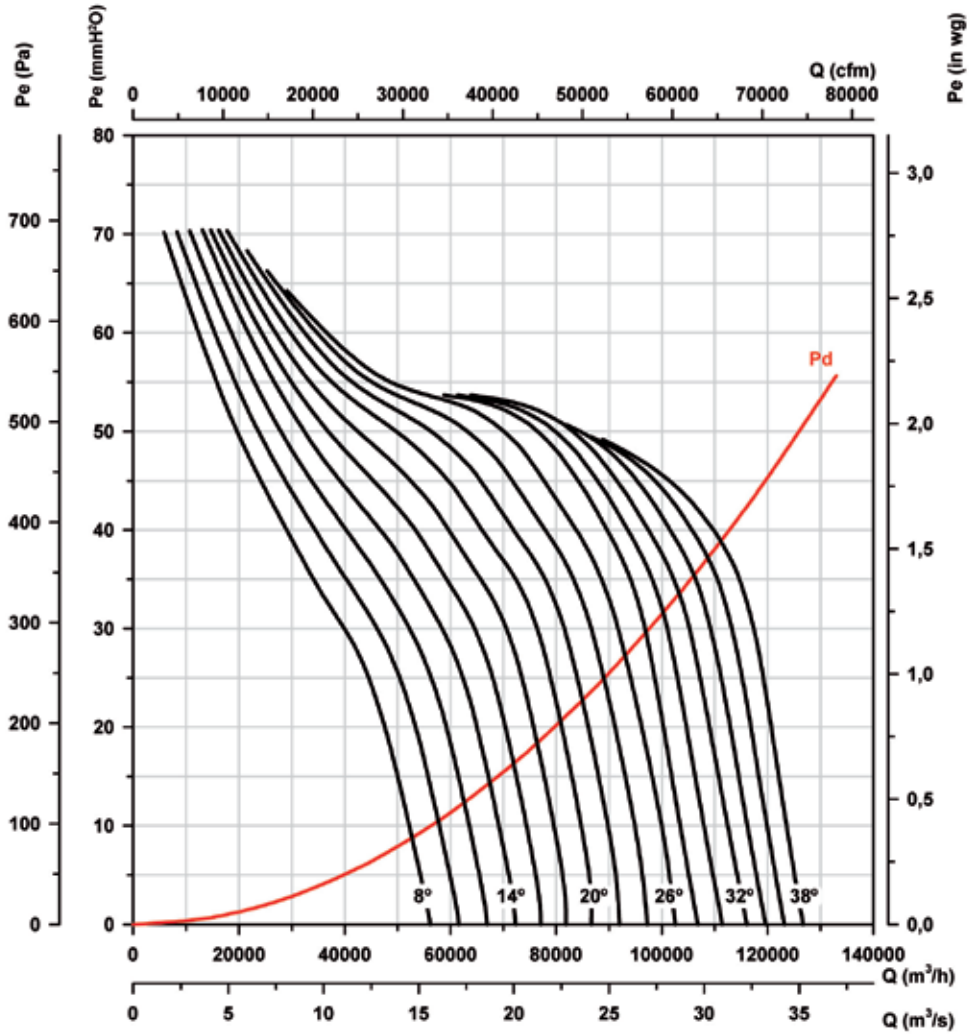

Potencia absorbida

Potencia Motor Recomendada kw(CV)

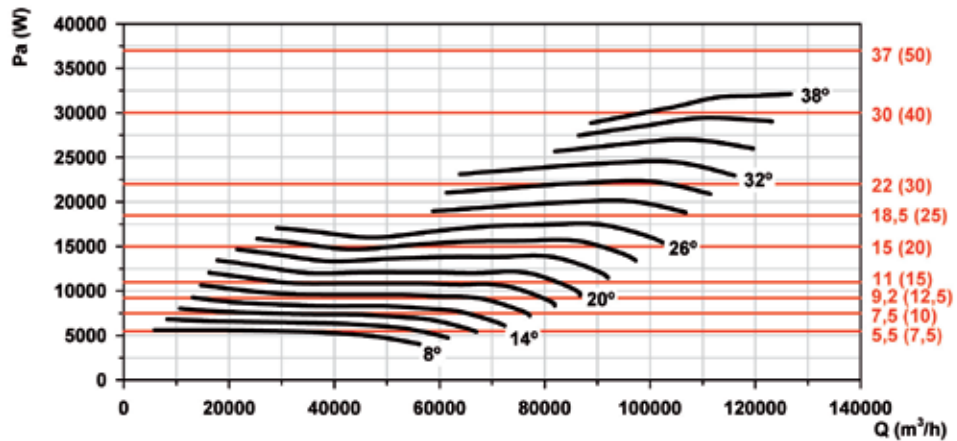

Curvas características

Q= Caudal en m³/h, m³/s y cfm.

Pe= Presión estática en mmH₂O, Pa e inwg.

Diámetro Hélice (cm): 125

Número de polos: 6

Número de palas: 9

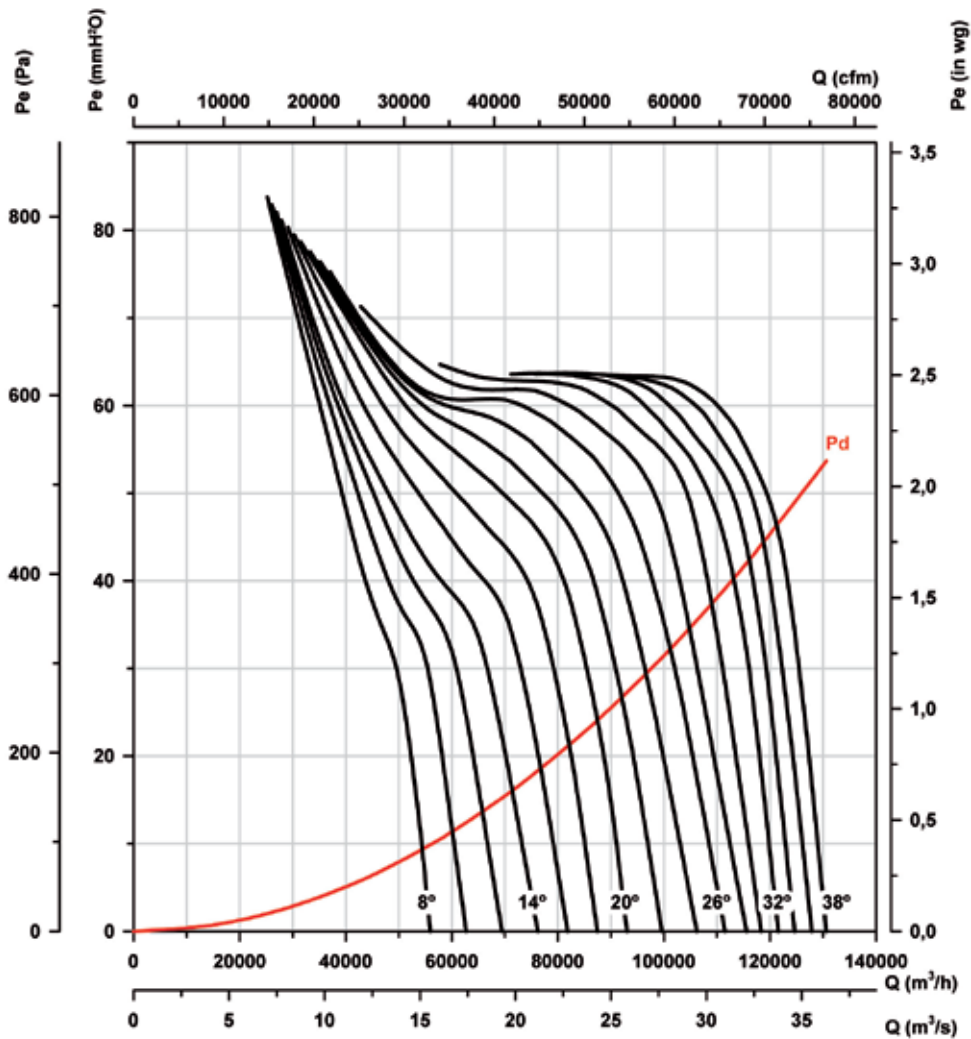

Potencia absorbida

Potencia Motor Recomendada kw(CV)

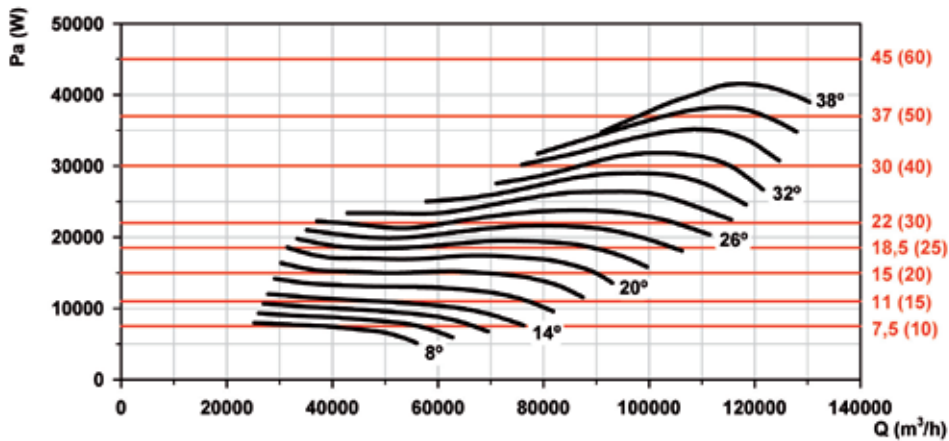

Curvas características

Q= Caudal en m³/h, m³/s y cfm. Pe= Presión estática en mmH₂O, Pa e inwg.

Diámetro Hélice (cm): 140

Número de polos: 6

Número de palas: 3

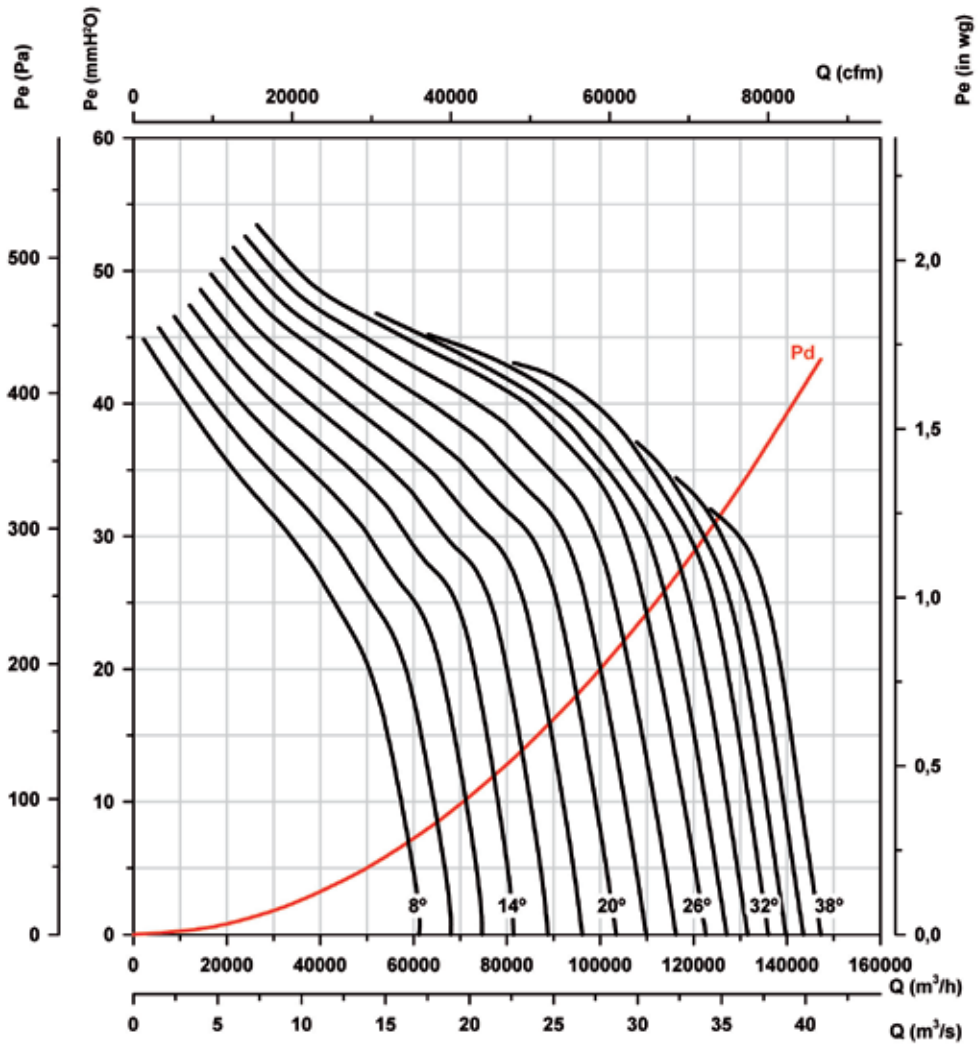

Potencia absorbida

Potencia Motor Recomendada kw(CV)

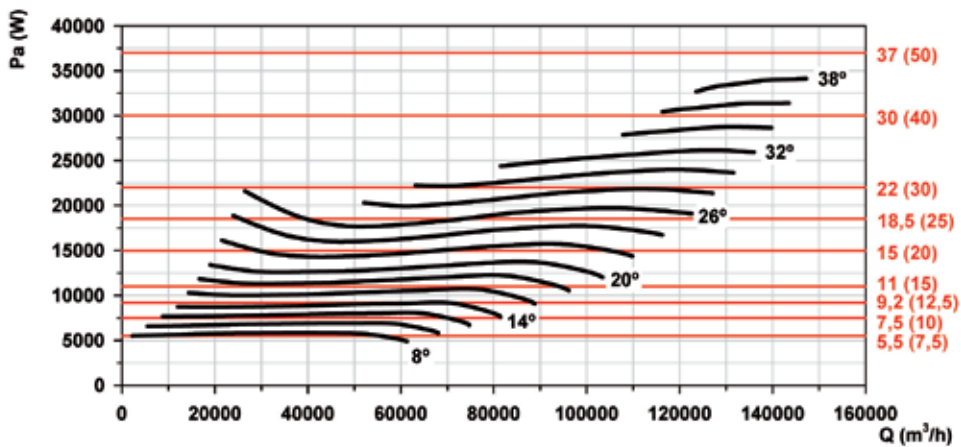

Curvas características

Q= Caudal en m³/h, m³/s y cfm.

Pe= Presión estática en mmH₂O, Pa e inwg.

Diámetro Hélice (cm): 140

Número de polos: 6

Número de palas: 6

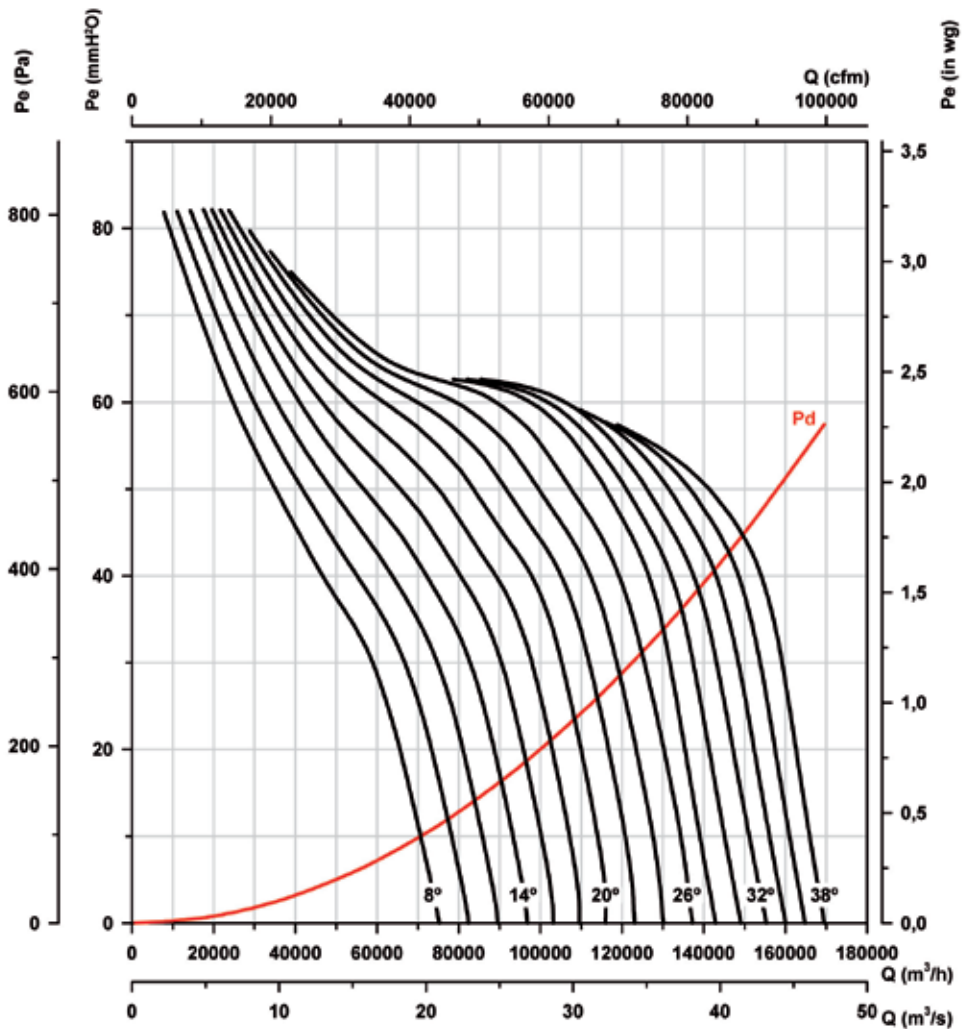

Potencia absorbida

Potencia Motor Recomendada kw(CV)

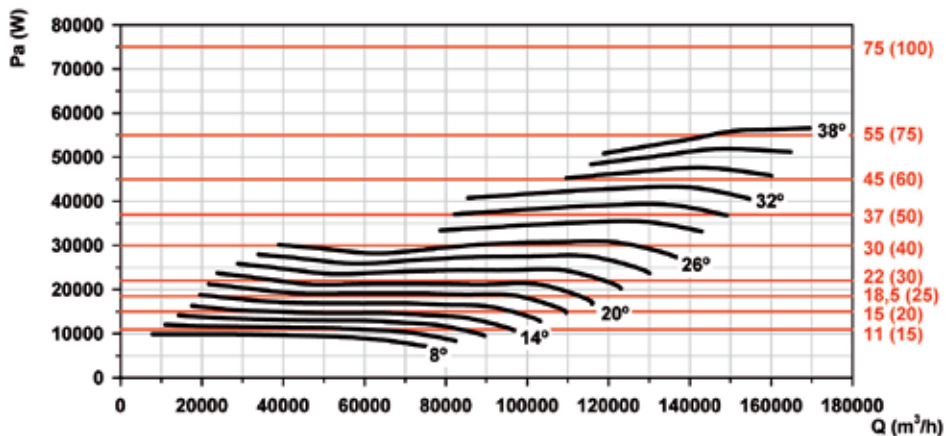

Curvas características

Q= Caudal en m³/h, m³/s y cfm.

Pe= Presión estática en mmH₂O, Pa e inwg.

Diámetro Hélice (cm): 140

Número de polos: 6

Número de palas: 9

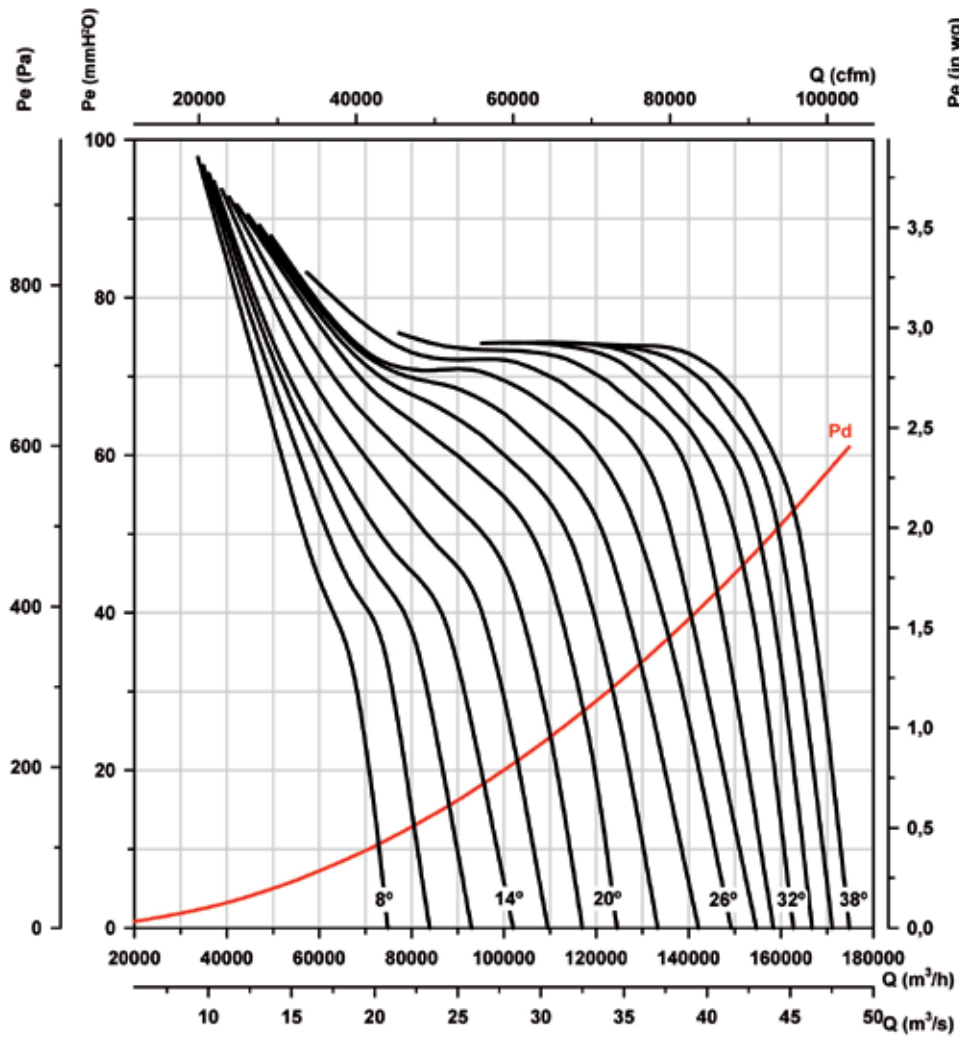

Potencia absorbida

Potencia Motor Recomendada kw(CV)

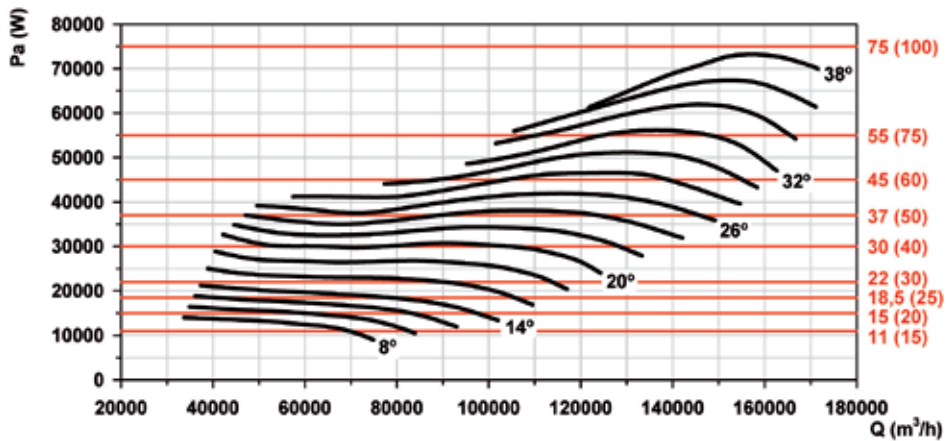

Curvas características

Q= Caudal en m³/h, m³/s y cfm.

Pe= Presión estática en mmH₂O, Pa e inwg.

Diámetro Hélice (cm): 140

Número de polos: 8

Número de palas: 3

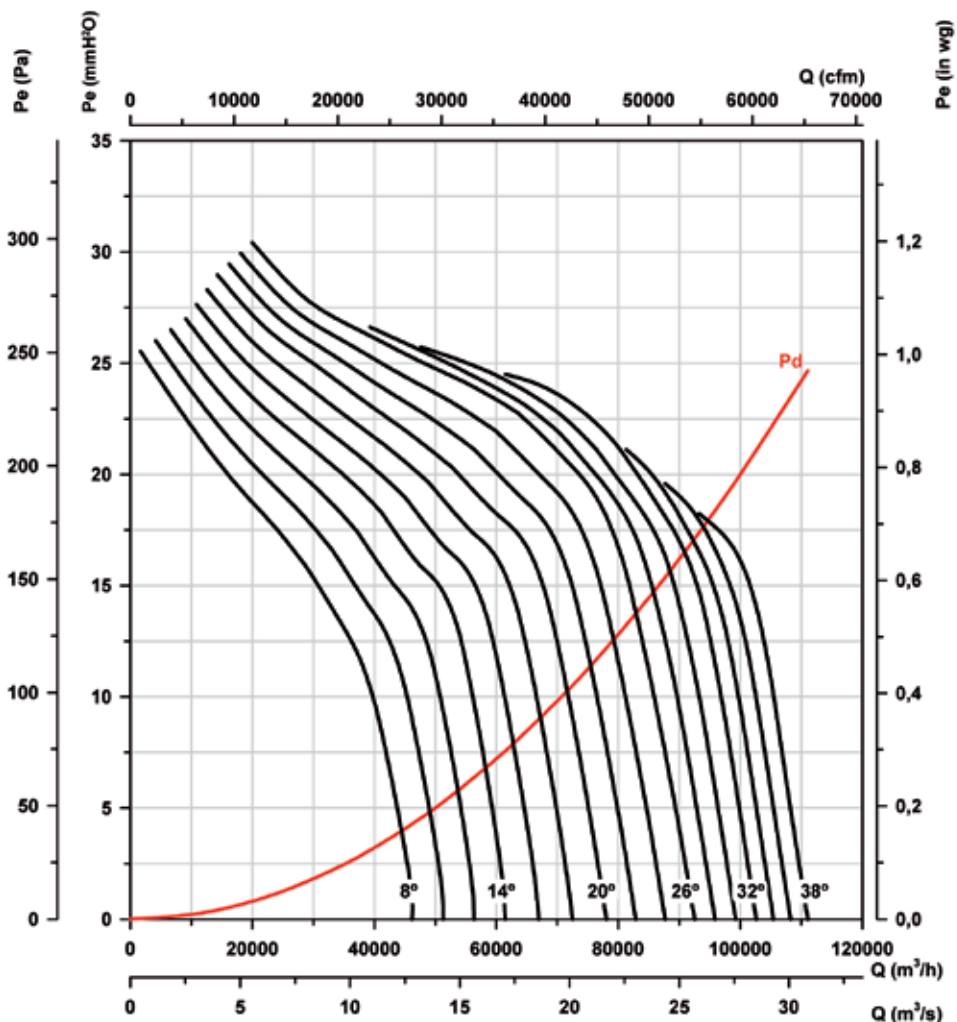

Potencia absorbida

Potencia Motor Recomendada kw(CV)

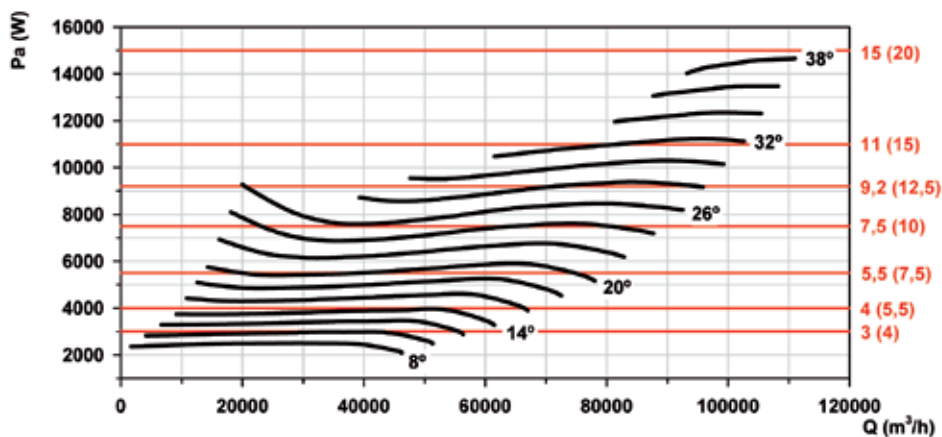

Curvas características

Q= Caudal en m³/h, m³/s y cfm. Pe= Presión estática en mmH₂O, Pa e inwg.

Diámetro Hélice (cm): 140

Número de polos: 8

Número de palas: 6

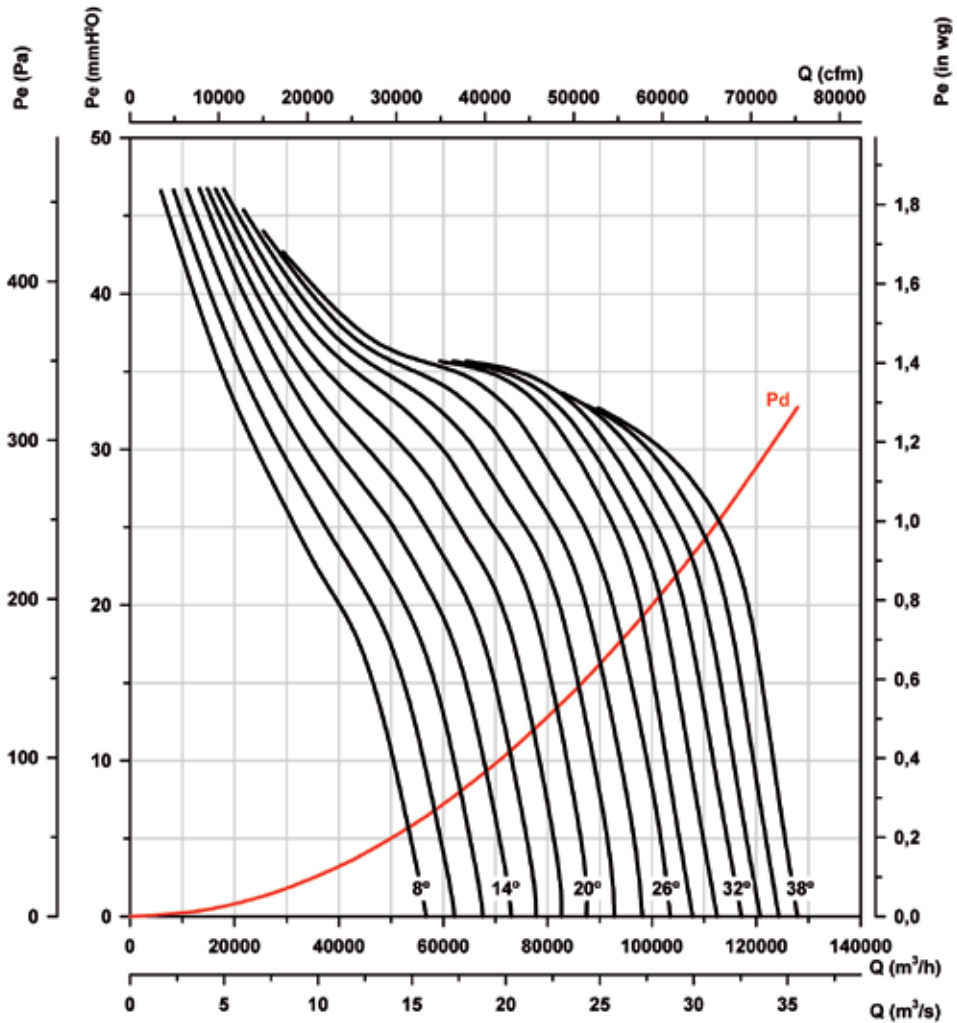

Potencia absorbida

Potencia Motor Recomendada kw(CV)

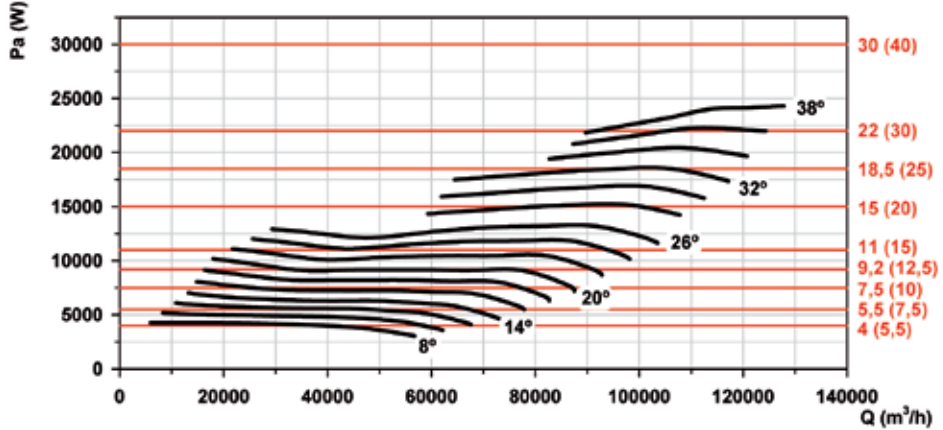

Curvas características

Q= Caudal en m³/h, m³/s y cfm.

Pe= Presión estática en mmH₂O, Pa e inwg.

Diámetro Hélice (cm): 140

Número de polos: 8

Número de palas: 9

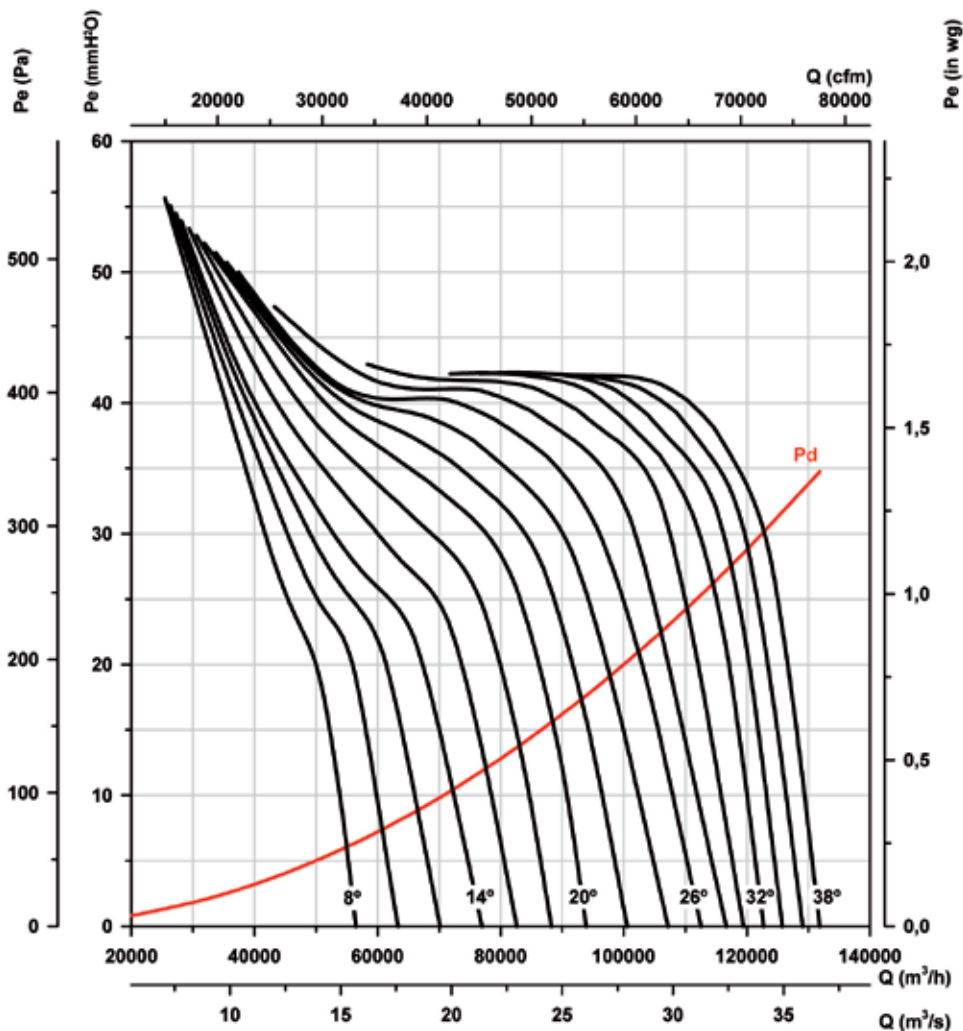

Potencia absorbida

Potencia Motor Recomendada kw(CV)

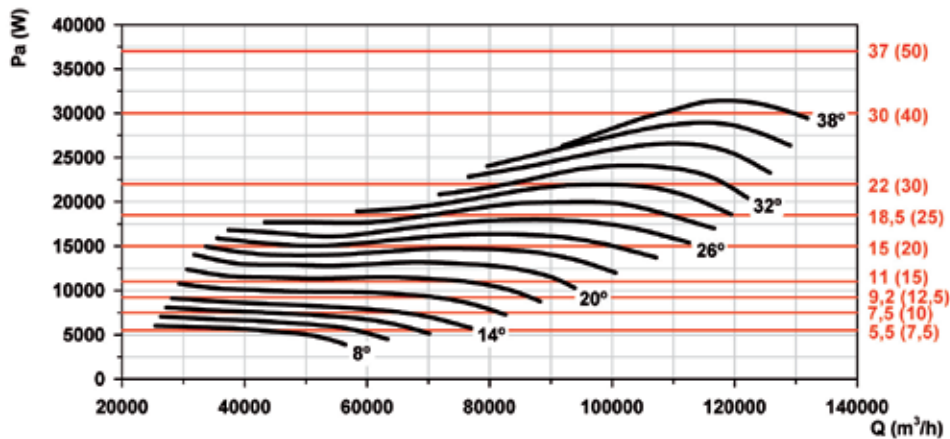

Curvas características

Q= Caudal en m³/h, m³/s y cfm.

Pe= Presión estática en mmH₂O, Pa e inwg.

Diámetro Hélice (cm): 160

Número de polos: 6

Número de palas: 3

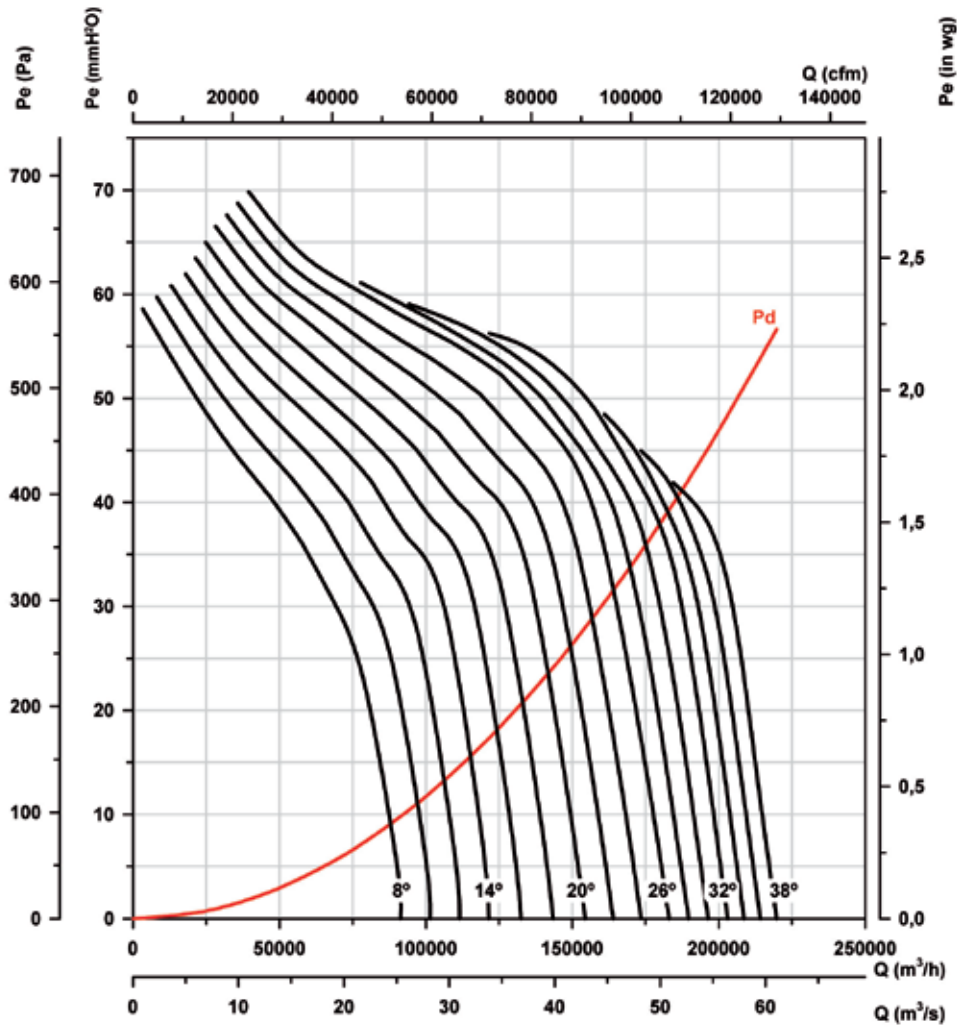

Potencia absorbida

Potencia Motor Recomendada kw(CV)

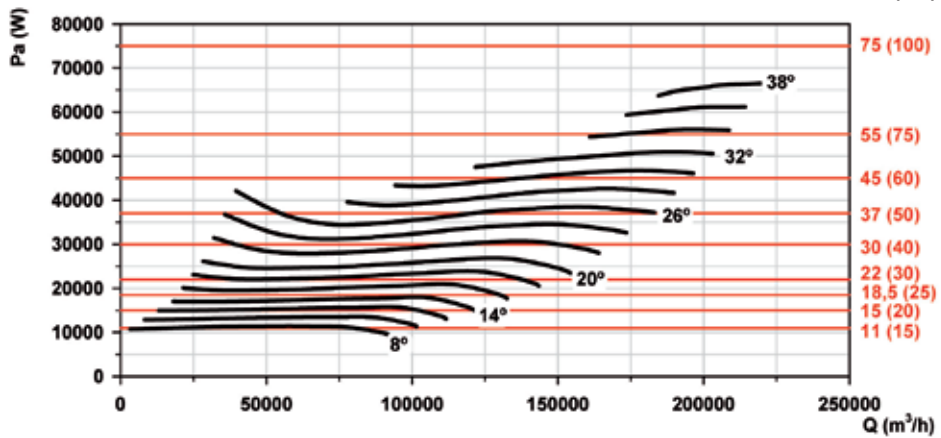

Curvas características

Q= Caudal en m³/h, m³/s y cfm.

Pe= Presión estática en mmH₂O, Pa e inwg.

Diámetro Hélice (cm): 160

Número de polos: 6

Número de palas: 8

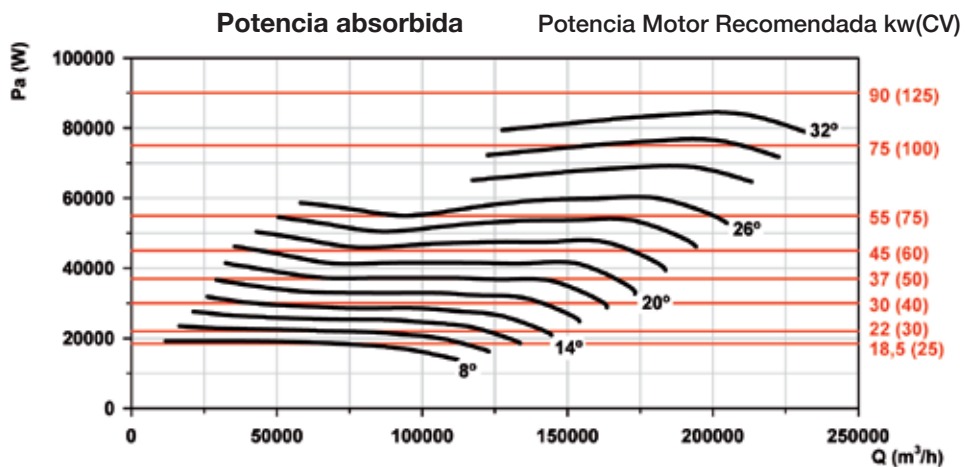
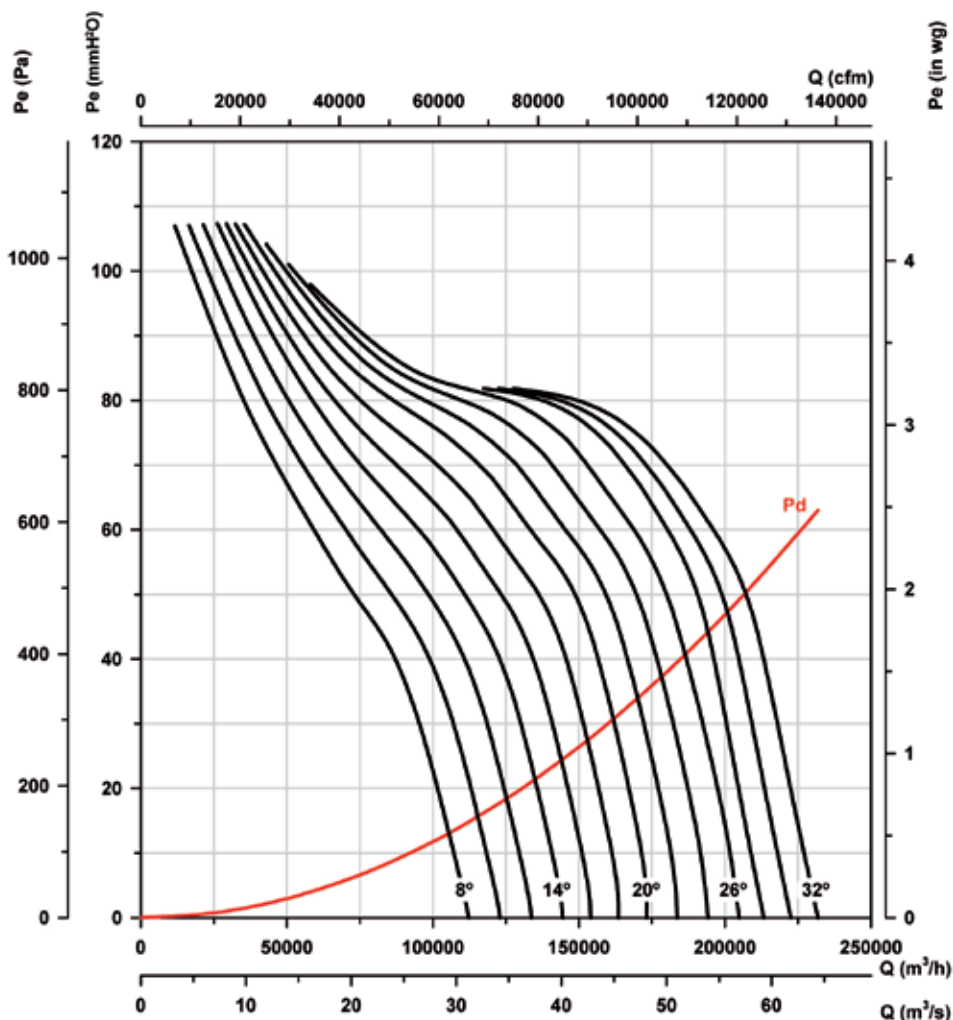

Curvas características

Q= Caudal en m³/h, m³/s y cfm.

Pe= Presión estática en mmH₂O, Pa e inwg.

Diámetro Hélice (cm): 160

Número de polos: 6

Número de palas: 9

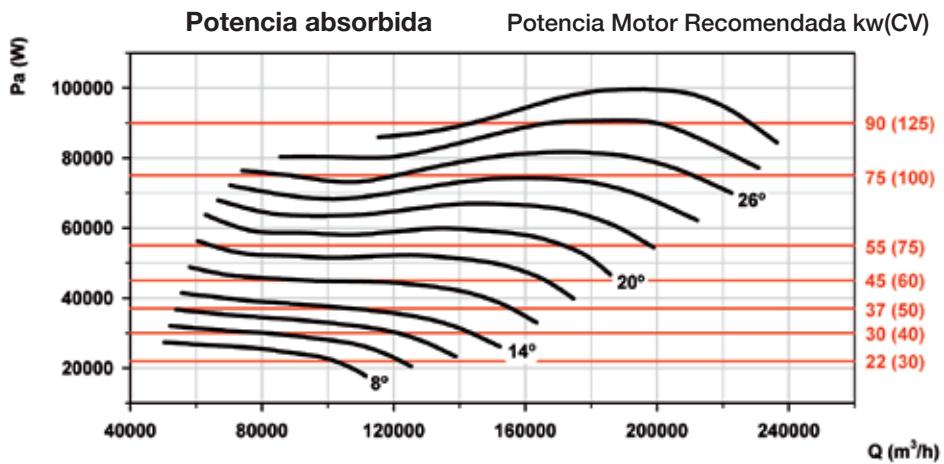
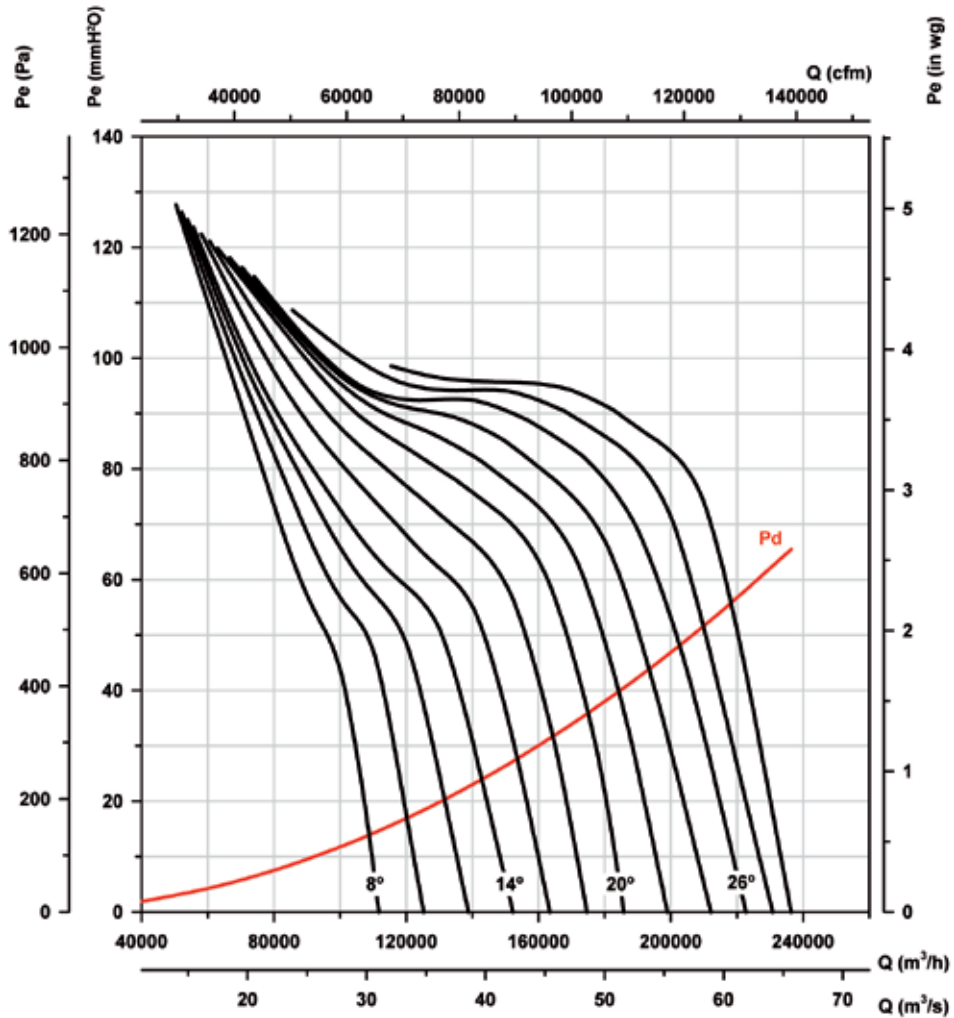

Curvas características

Q= Caudal en m³/h, m³/s y cfm.

Pe= Presión estática en mmH₂O, Pa e inwg.

Diámetro Hélice (cm): 160

Número de polos: 8

Número de palas: 3

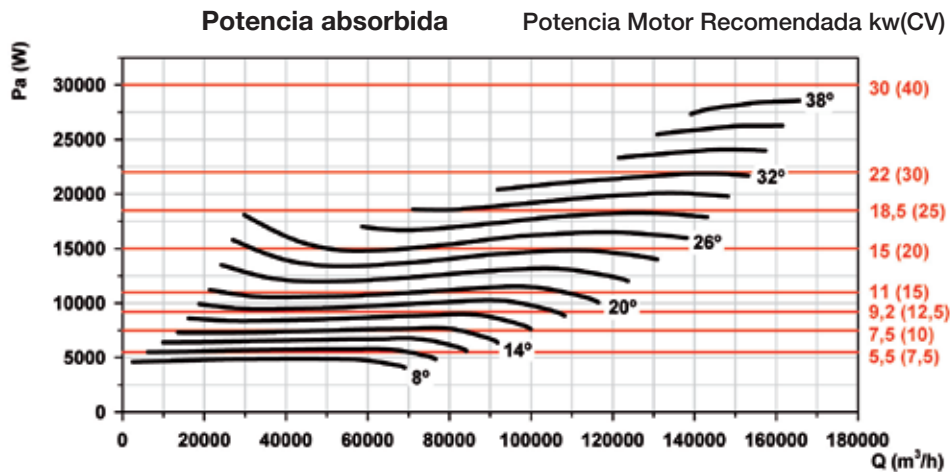
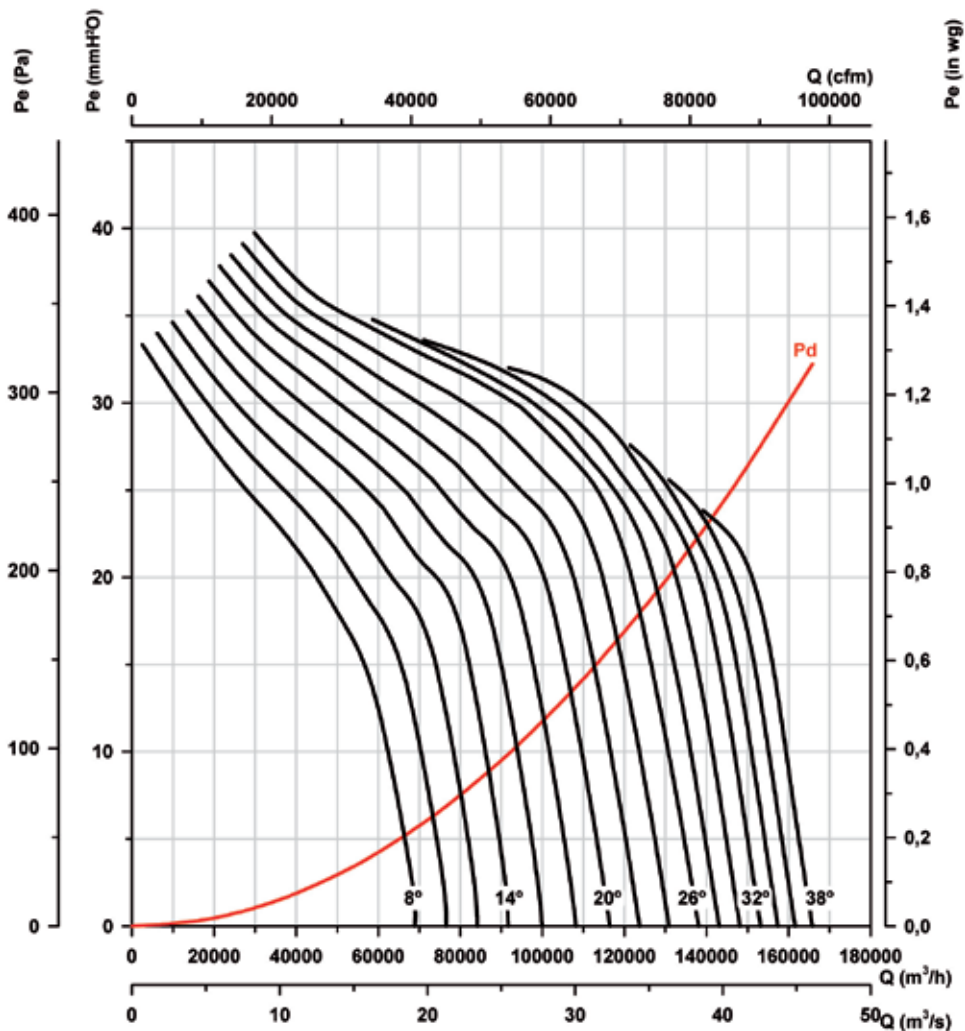

Curvas características

Q= Caudal en m³/h, m³/s y cfm. Pe= Presión estática en mmH₂O, Pa e inwg.

Diámetro Hélice (cm): 160

Número de polos: 8

Número de palas: 6

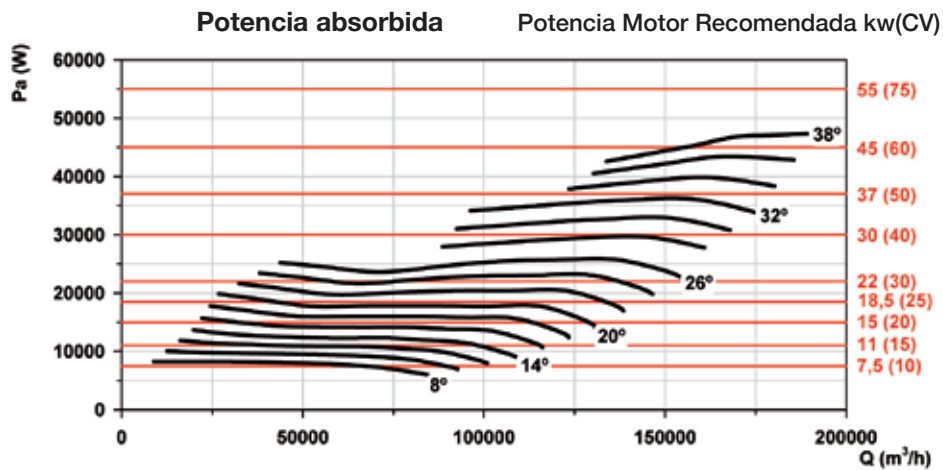
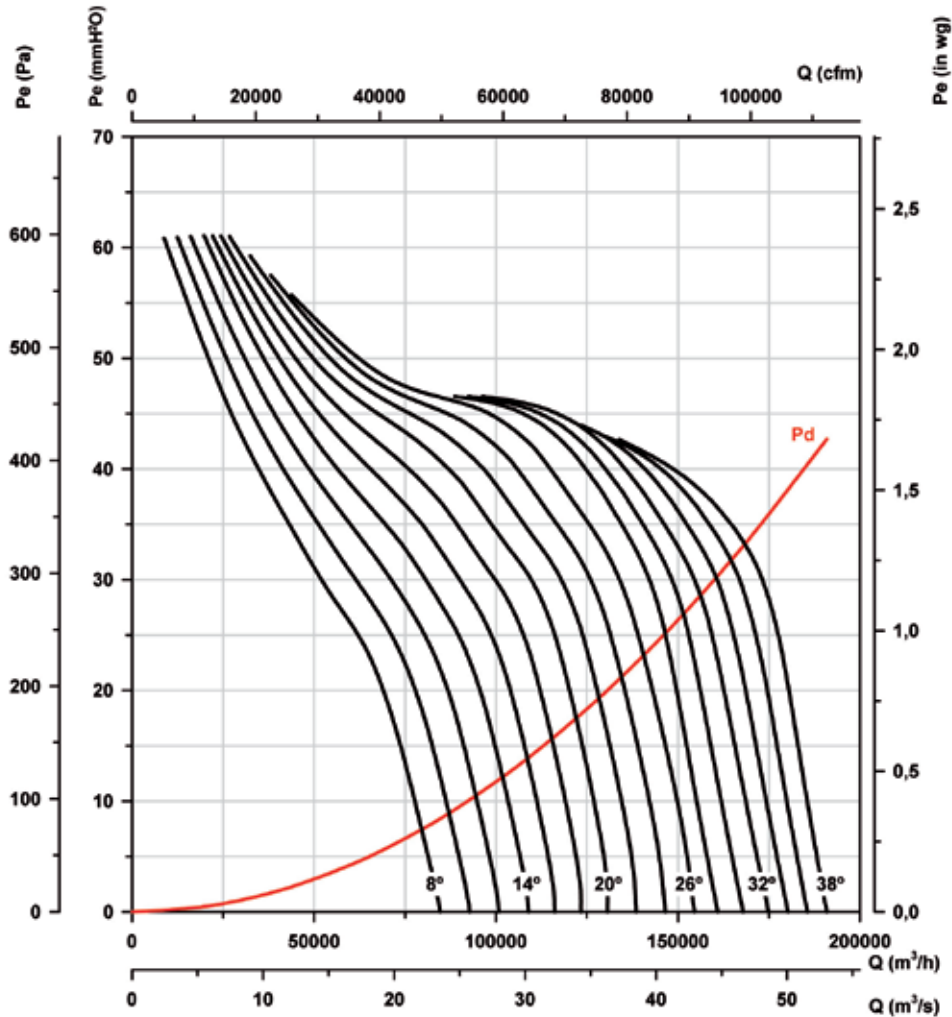

Curvas características

Q= Caudal en m³/h, m³/s y cfm.

Pe= Presión estática en mmH₂O, Pa e inwg.

Diámetro Hélice (cm): 160

Número de polos: 8

Número de palas: 9

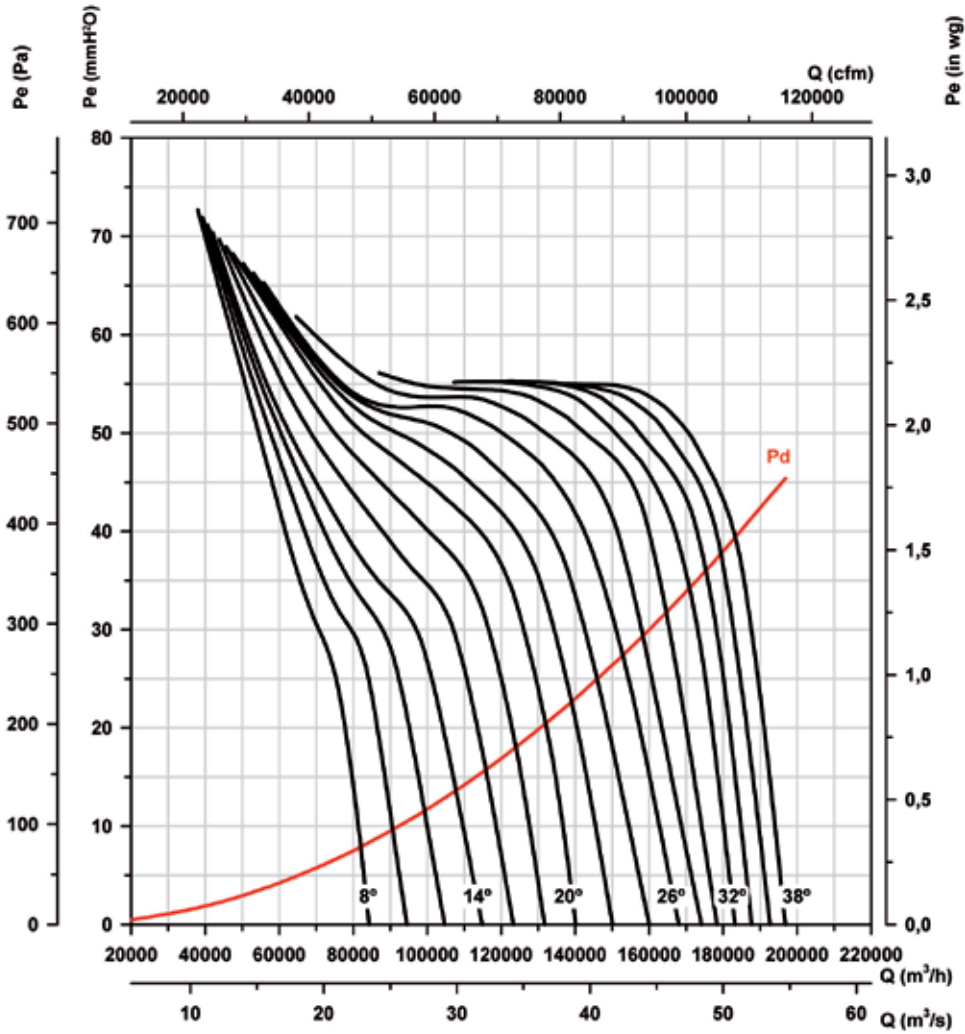

Potencia absorbida

Potencia Motor Recomendada kw(CV)

